

# A Field Day: Some Physics You May Find Useful

Olaf Hauk

[olaf.hauk@mrc-cbu.cam.ac.uk](mailto:olaf.hauk@mrc-cbu.cam.ac.uk)

Introduction to Neuroimaging Methods, 1.4.2019

# Challenges of Interdisciplinary Research

We are interested in cognitive/brain functions – based on evidence from physical measurements:  
Keep track of the inferential chain from measurement to conclusion.

## VEPs

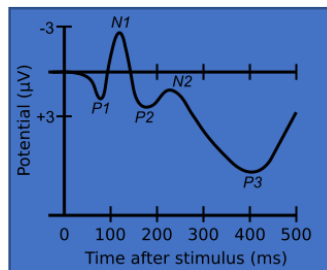
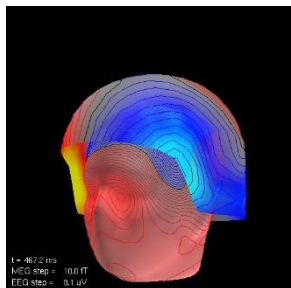

[http://en.wikipedia.org/wiki/Visual\\_N1](http://en.wikipedia.org/wiki/Visual_N1)

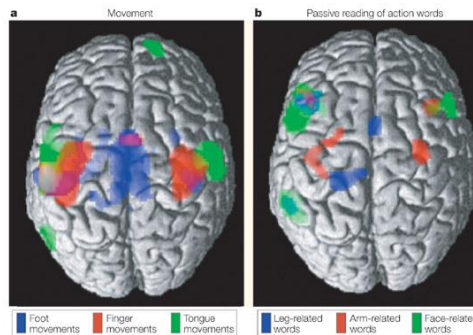

Copyright © 2005 Nature Publishing Group  
Nature Reviews | Neuroscience

## SSVEP

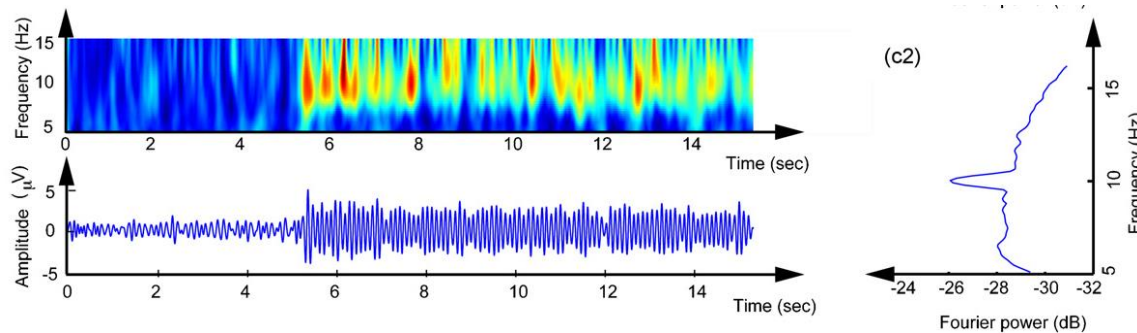

Vialatte et al., Progr Neurobiol 2010

# Newton's Laws of Motion

A good example for linking theory and measurement



- 1) An object only changes its velocity in reaction to an external force
- 2)  **$F = m \cdot a$** : The net force acting on an object is proportional to its mass and its acceleration ( $\Rightarrow a = F/m$ )
- 3) If one body exerts a force on a second body, the second body exerts a force of the same magnitude on the first body (“actio et reactio”)

N.B.: We use the term “Weight” wrong. It should refer to the force on mass under gravitation, i.e. be measured in Newtons (e.g. our weight is different on the moon, but mass is not).

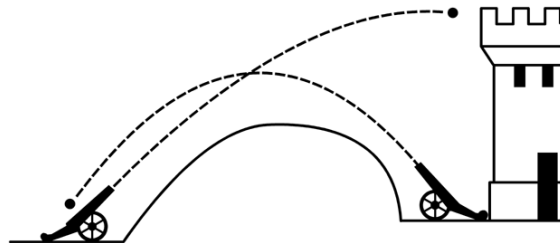



# The (Gravitational) Potential Potential Energy

A potential is only defined between two states/locations.

## “Gravitational Potential”:

Energy required to move an object of unit mass to a reference location.

For example:

“How much energy can I gain by dropping my shoe from the roof?”  
only makes sense if I specify how far it can fall – to the balcony? To the ground?  
To sea level? To the middle of earth?

Reciprocity:

The energy you get from dropping it you will need to  
lift it back to its original position.



# The Potential, Potential Energy

The Pendulum:  
Conversion of potential energy into kinetic energy and vice versa

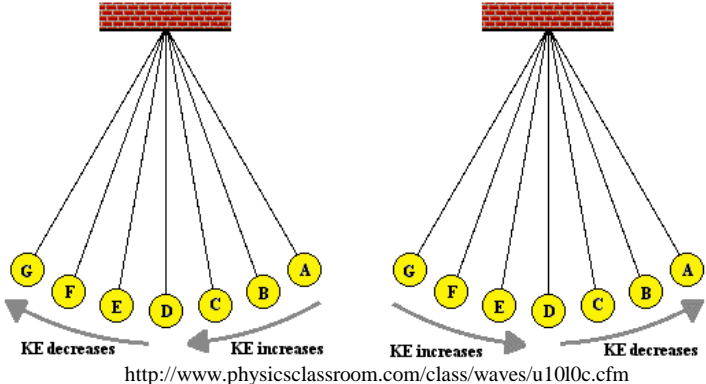

Electric oscillator:  
Conversion of voltage into current and vice versa

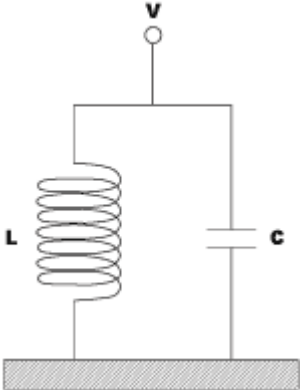





# Electricity: Voltage and Current

Voltage:

Difference in electric potential between two points

or

Energy required to move an electric unit charge between two points

( $1V = 1 \text{ "Joule per Coulomb"} = 1 \text{ J/C}$ )

Hydraulic Analogy:

Pressure ~ Voltage, Flow ~ Current

Resistance ~ Size of tube

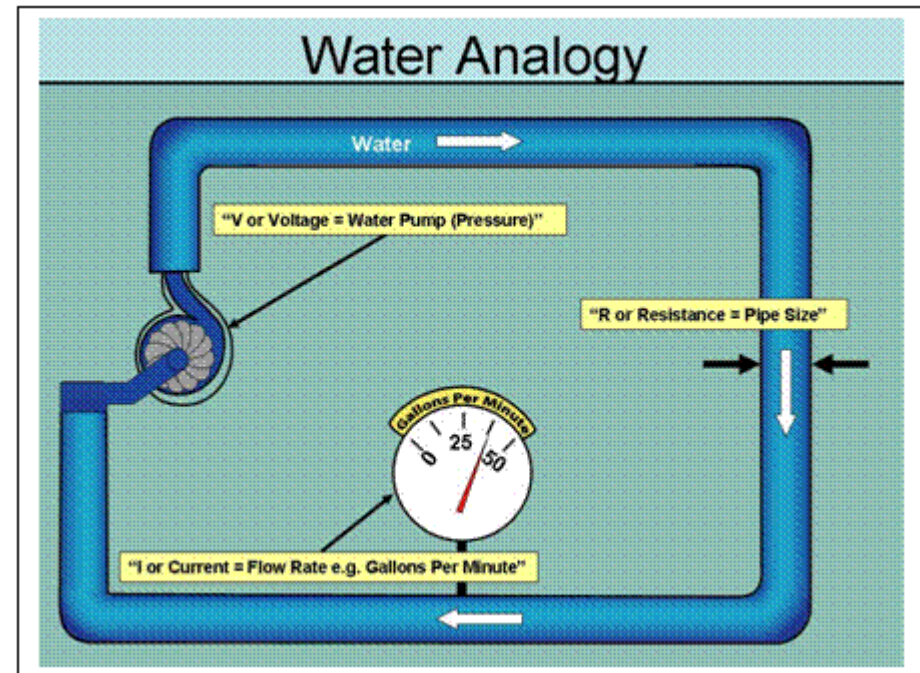

# Electricity: Ohm's Law

For a given voltage, the current depends on the **resistance** of the conductor:

$$I = U / R$$

("Ohm's Law")

(*I*: current (Ampere), *U*: voltage (Volt), *R*: resistance (Ohm, "Ω"))

If you can measure the voltage and the current, you can get the resistance:

$$R = U / I$$

Sometimes it is more convenient to talk about "**Conductance**":

$$G = 1 / R$$

(*G*: conductance (Siemens))

Resistance can depend on the frequency of voltage/current, and it may affect amplitude and phase of a time-varying current. More general:

**"Impedance"**

(complex number)





# Current Flow in the Head

Conductances, currents etc. can vary with location (e.g. in different brain tissues)

They are often expressed as densities (per length, per area, per volume), e.g.

“resistance per unit length”  
(Ohms per m etc.)



“current per unit area”  
(A/m<sup>2</sup>, pA/cm<sup>2</sup> etc.)

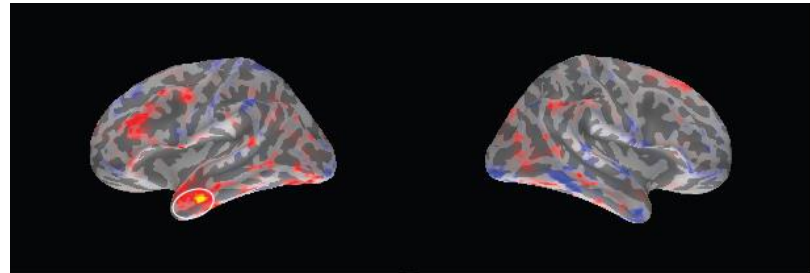



# Examples of Voltages, Currents and Resistance

Household Batteries

~ 1-12 V



Membrane Potentials

~ 70 mV

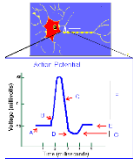

ECG

~ 1mV



ERPs

~ 1-10  $\mu$ V



Copper (resistivity  
17n $\Omega$ \*m)

Wire (10m, 1 mm<sup>2</sup>;  
~ 0.2  $\Omega$  ~ 5 S



Voltage

1V ->

Current

5A

(short  
circuit)



Skull ~ 70  $\Omega$ m

Brain+scalp ~ 1  $\Omega$ m

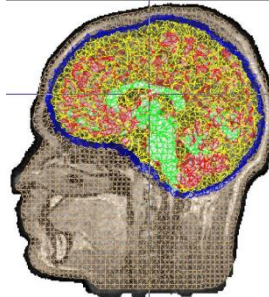

<http://www.sourcesignal.com/mrviewer.html>

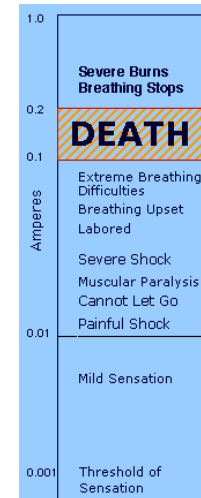

[http://www.physics.ohio-state.edu/~p616/safety/fatal\\_current.html](http://www.physics.ohio-state.edu/~p616/safety/fatal_current.html)

# Nerves Are Not Wires

Action potentials are caused by active cellular mechanisms, not passive “Ohmic” currents

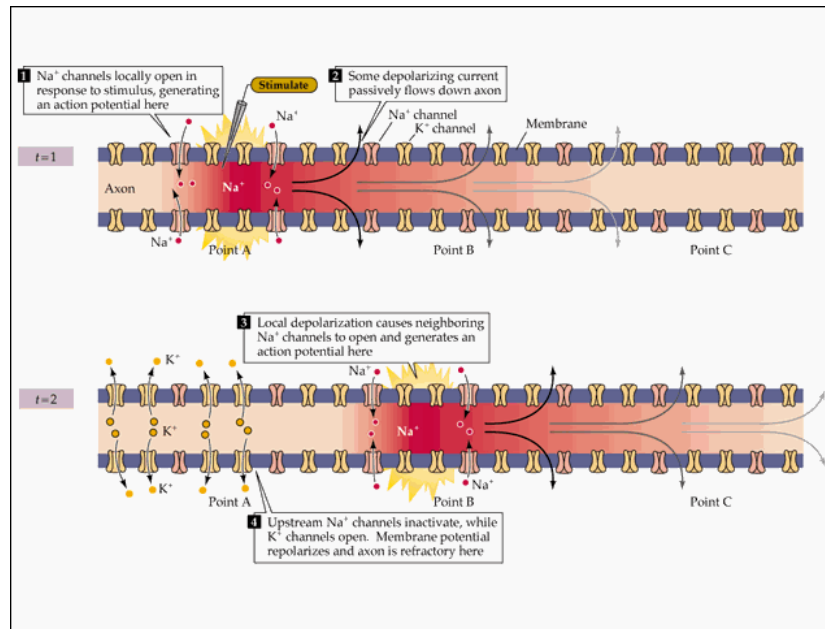

<http://www.arts.uwaterloo.ca/~bfleming/psych261/lec4se21.htm>

Electric energy travels at ~ speed of light.  
Electrons' drift speed ~ centimetre per second (copper wire).  
Action potentials ~ 10-50 meters per second.



# Electric Fields

Charges can act on each other without a conducting medium between them.

⇒ Electric field

⇒ Electric field lines: The path along which a positive charge would travel.

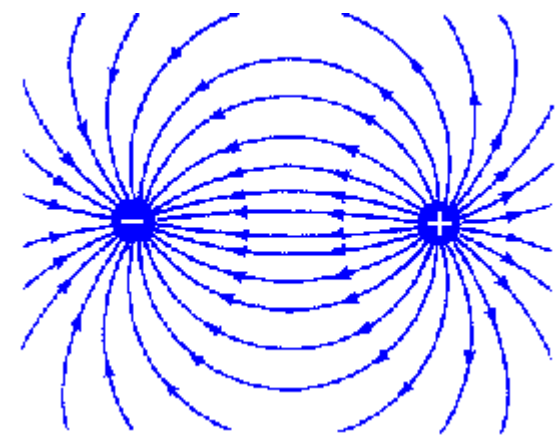
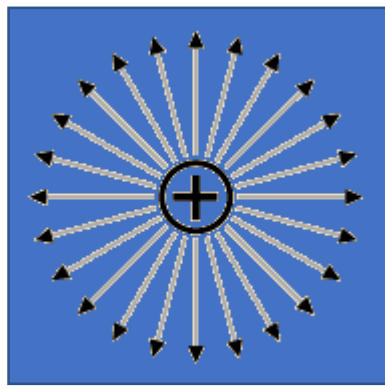

When a conductor is placed into an electric field, charges move along field lines.

⇒ Current density:  $J = \sigma E$  (*conductivity \* electric field strength*)



# Example: Current Flow In The Head

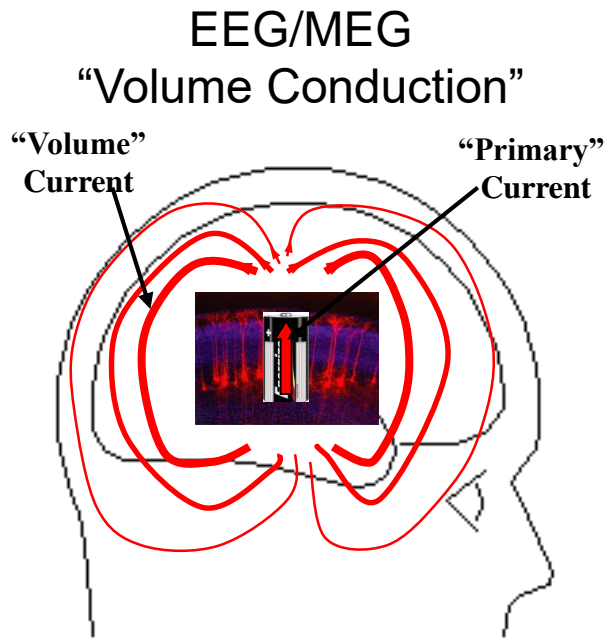

### tDCS Transcranial direct current stimulation

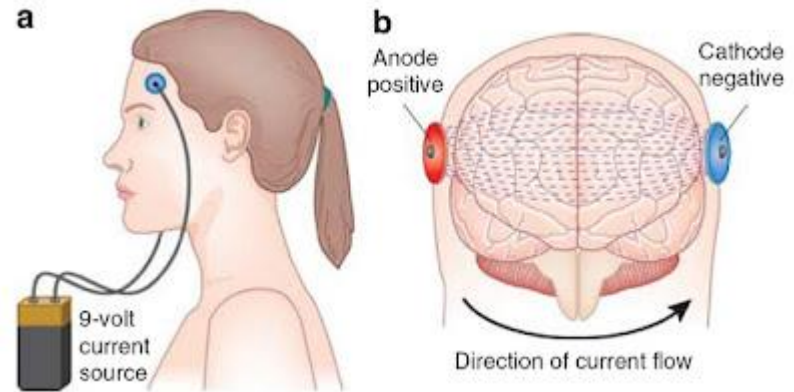

# Coulomb's Law

For a single charge: Electric field decreases with squared distance (in vacuum)

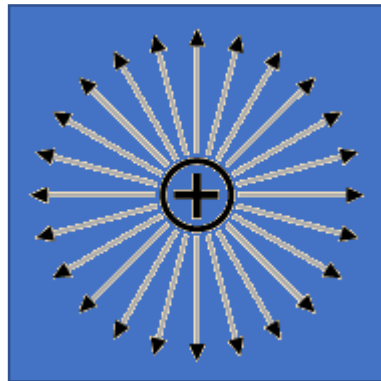

$$E(r) = \frac{1}{4\pi\epsilon_0} \frac{q}{r^2}$$

For a “dipole”: Electric field decreases ~ with cubic distance (in vacuum)

[http://en.wikipedia.org/wiki/Electric\\_dipole\\_moment](http://en.wikipedia.org/wiki/Electric_dipole_moment)

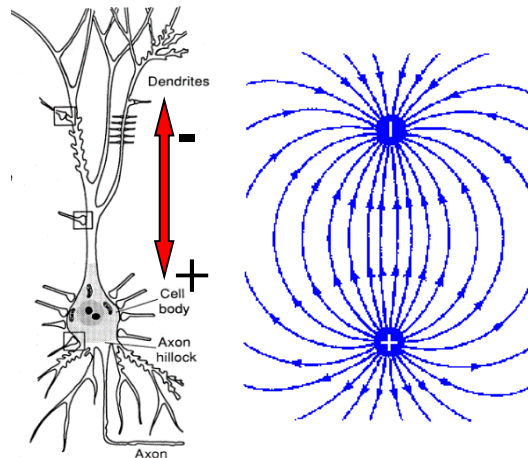



# Magnetic Fields

## Bar magnets

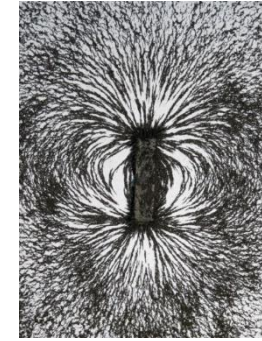
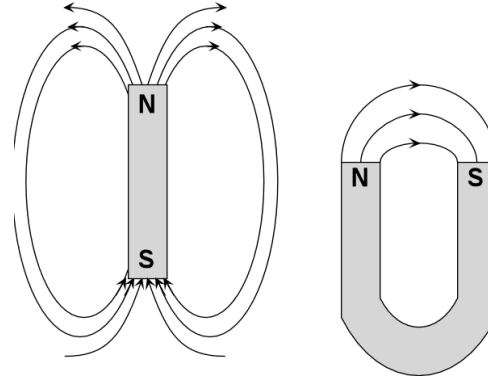

## Currents

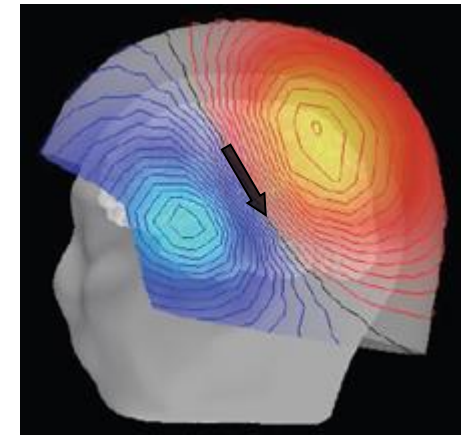
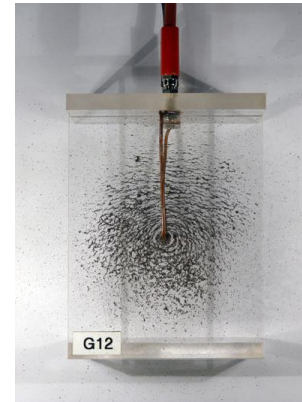
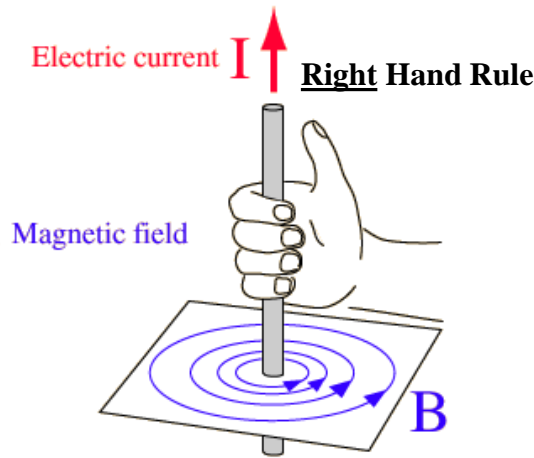

There are no “magnetic monopoles”, field lines are always closed.



# Magnetic Fields

The Biot-Savart Law describes the magnetic field due to a current (in vacuum):

$$B(r) = \frac{\mu_0}{4\pi} \frac{dI \times r}{r^2}$$

The magnetic field strength decreases with squared distance to current.

The magnetic field direction is perpendicular to the current flow.

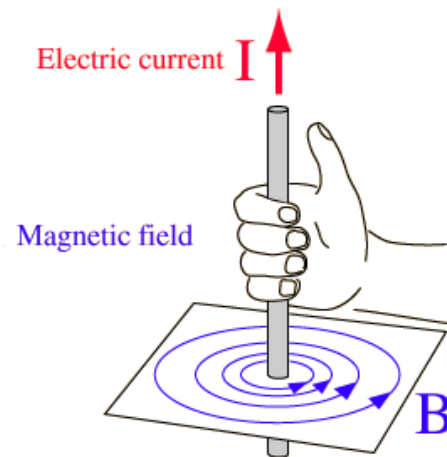





# Magnetic Induction

## Faraday's Law of Induction:

The induced current in the coil is proportional to the rate of magnetic flux change inside the coil

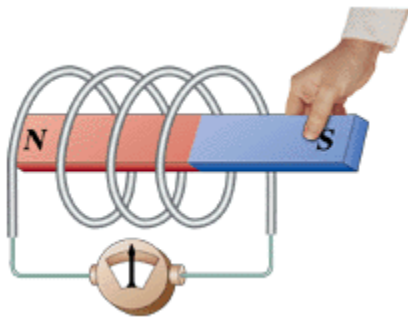

TMS pulse duration  $\sim 100 \mu\text{s}$ ,  $\sim 1\text{T}$   
Induced currents  $\sim \text{mA}$

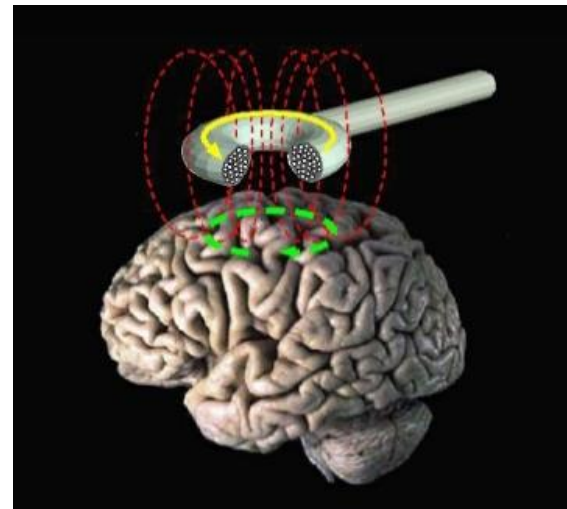



# Eddy Currents

A changing magnetic field induces an electric current in a conductor (“Eddy Current”).

Moving the conductor (e.g. body) can change the magnetic field around it.

The induced electric current may produce heat.

An electric current in a magnetic field receives a force.

Watch:

<https://www.youtube.com/watch?v=mJoPwQpBU9w>



# Maxwell's Equations (Classical Electrodynamics)

They describe mathematically how electric and magnetic fields are generated and altered by each other and by electric charges and currents.

- The summed electric flux around a close surface is proportional to the total electric charge enclosed within this surface (Gauss's Law)

$$\nabla \cdot \mathbf{E} = \frac{\rho}{\epsilon_0}$$

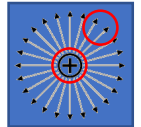

- Magnetic field lines are closed (Gauss's Law for magnetism)*

$$\nabla \cdot \mathbf{B} = 0$$

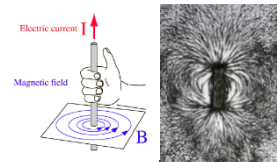

- Changing magnetic fields produce an electric field proportional to the rate of change (Faraday's Law of Induction)*

$$\nabla \times \mathbf{E} = -\frac{d\mathbf{B}}{dt}$$

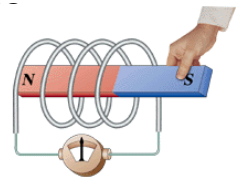

- Magnetic fields can be caused by currents and changing electric fields (Ampere's Law)*

$$\nabla \times \mathbf{B} = \mu_0 \left( \mathbf{J} + \epsilon_0 \frac{d\mathbf{E}}{dt} \right)$$

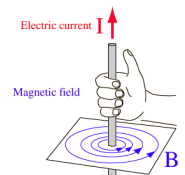

# Electromagnetic Waves

Temporally changing electric and magnetic fields induce each other:

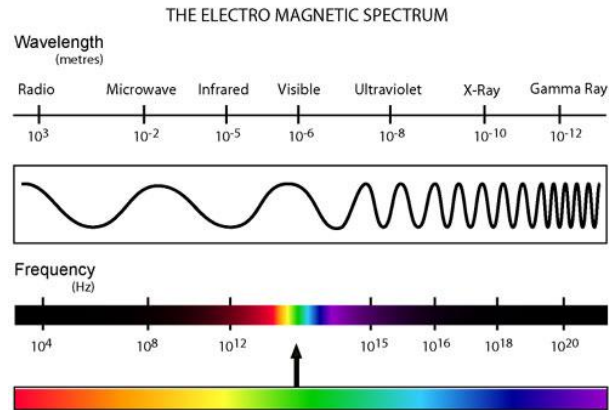
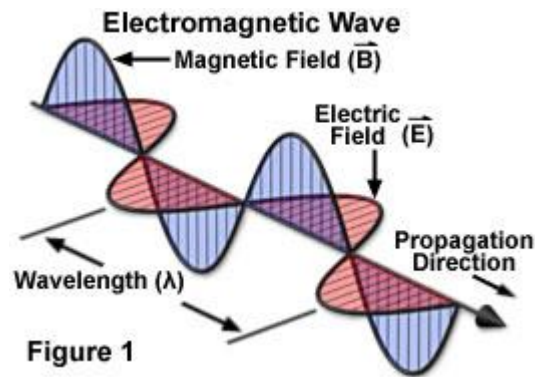

The energy of an electromagnetic wave decreases with distance squared.





# Wave Properties: Diffraction and Interference

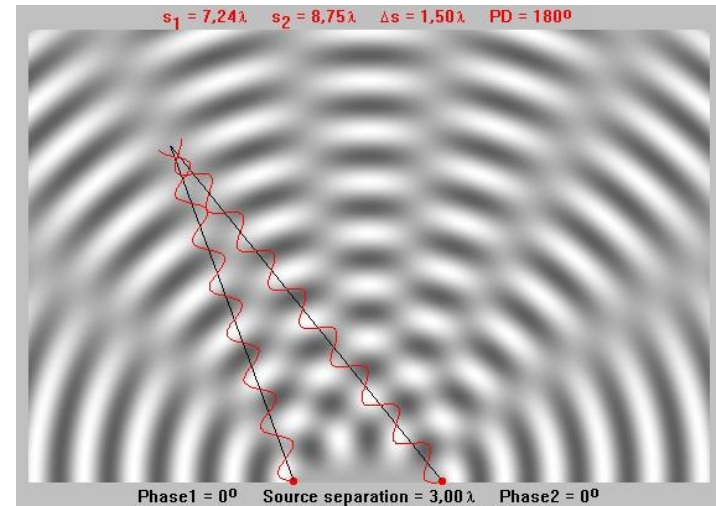
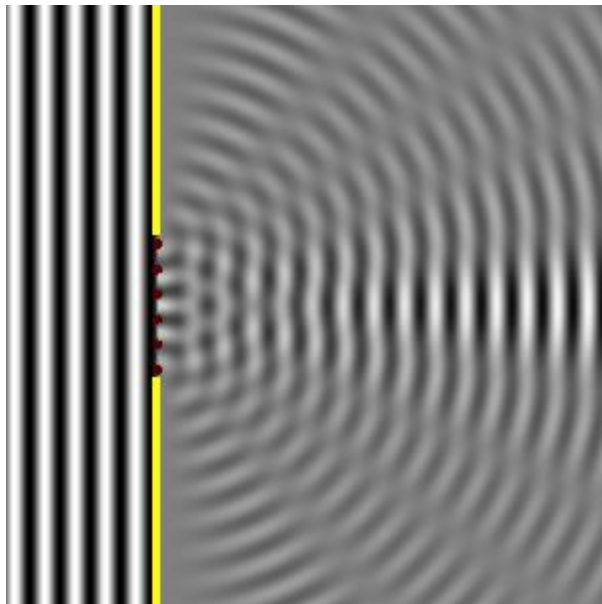



# Atoms

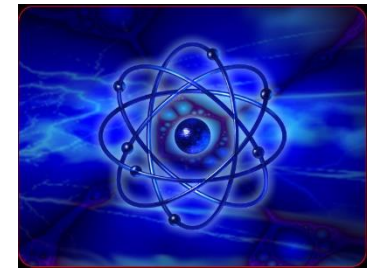

## Bohr's Model

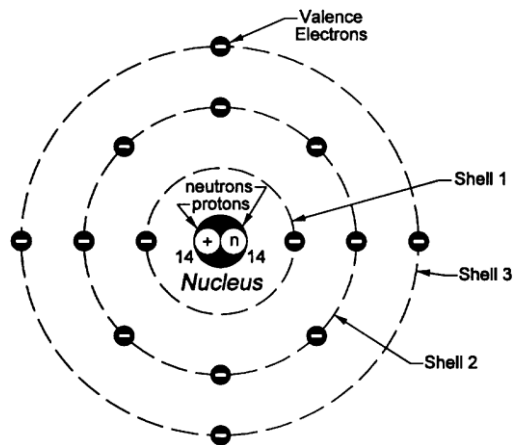

“Atomic number”: 14

Electron “orbits” are associated with different energy levels

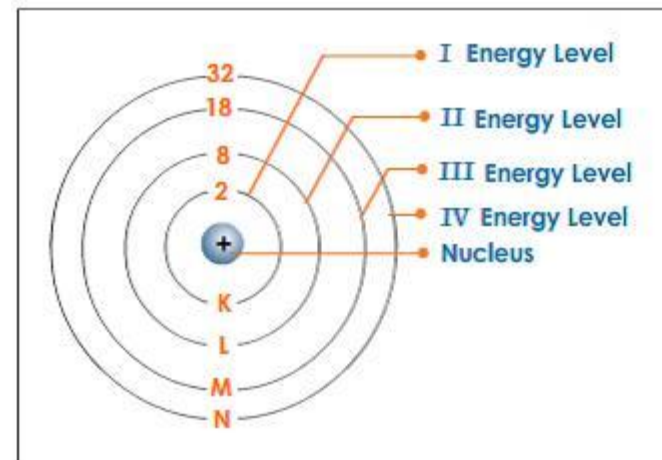

# International Year of the Period Table

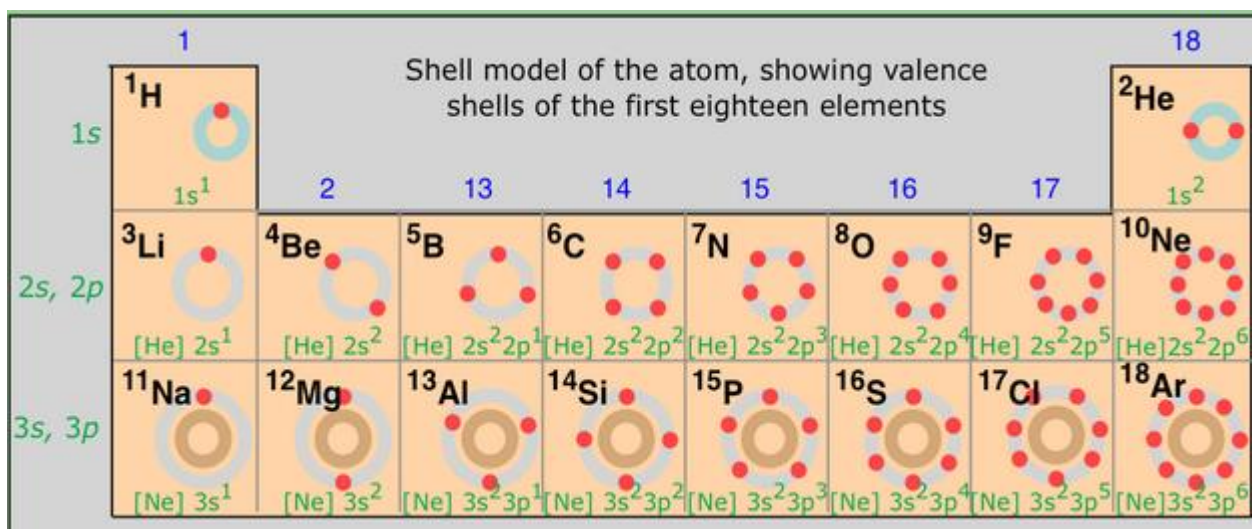

<https://courses.lumenlearning.com/boundless-chemistry/chapter/the-history-of-the-periodic-table/>

# Atoms and Electromagnetic Waves

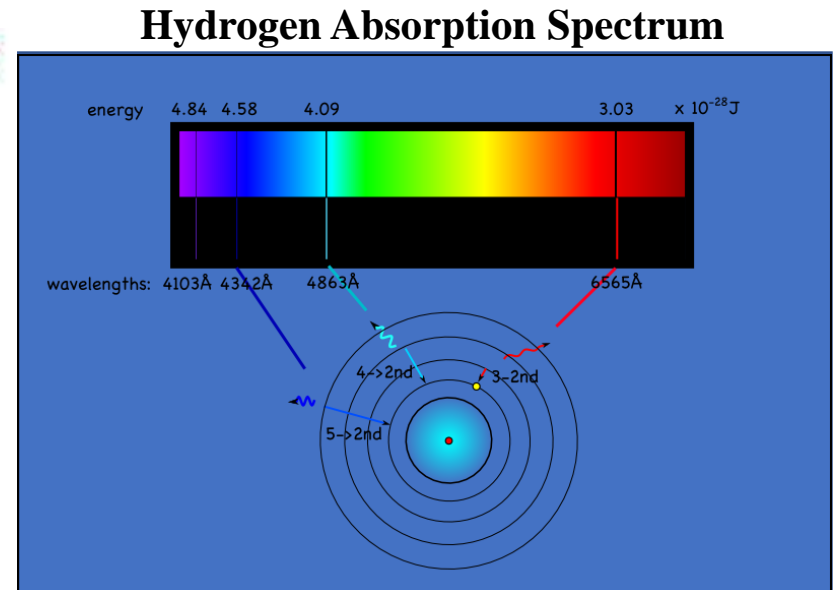
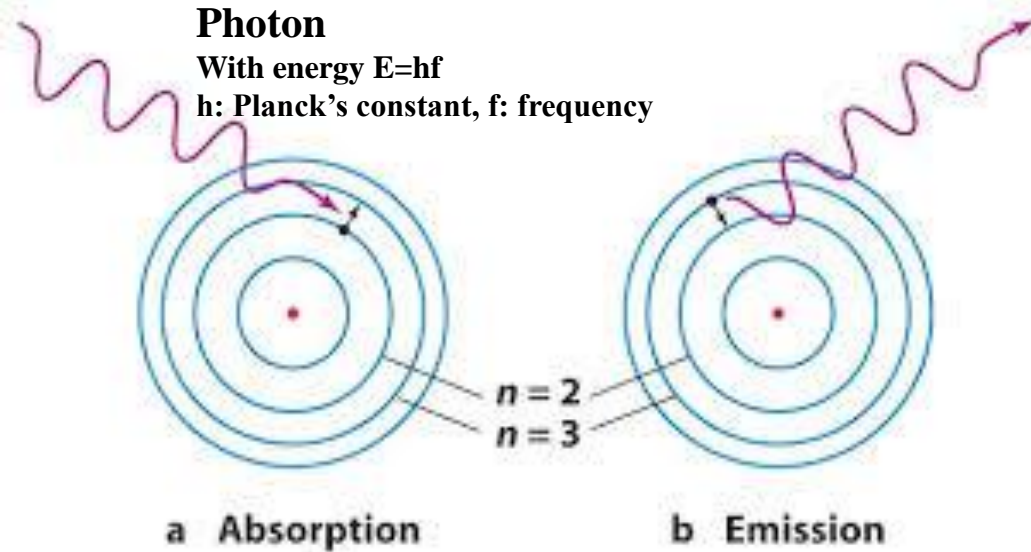

This is a bit like “potential energy” on earlier slides, but there are only distinct energetic states of the system, i.e. energy can only be absorbed or emitted in discrete “quanta”.





# Atomic Spin

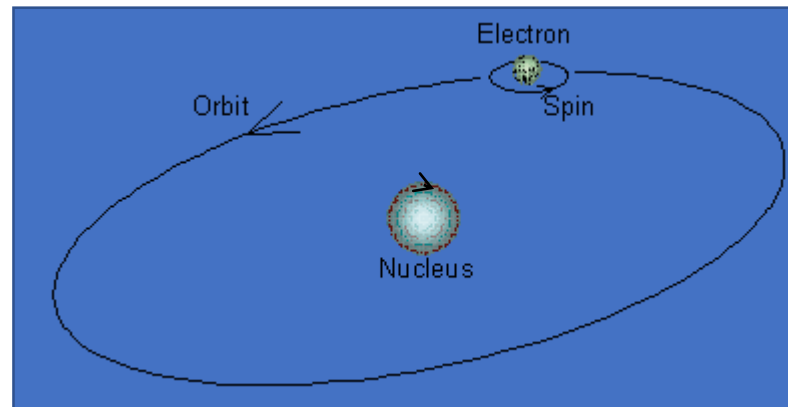

“Atomic Spin” is a purely quantum physical phenomenon.

It can be illustrated as rotation of a particle around its own axis.

In Bohr’s classical atomic model, electrons orbit around the nucleus.

⇒ A moving charge acts like a current, producing a magnetic field.

⇒ Related to magnetism.

Spin exists for many particles, including electrons and protons.

Spins can be in two states: “up” and “down”.

There are rules about how spins within one orbit are aligned to each other.



# Atomic Spin

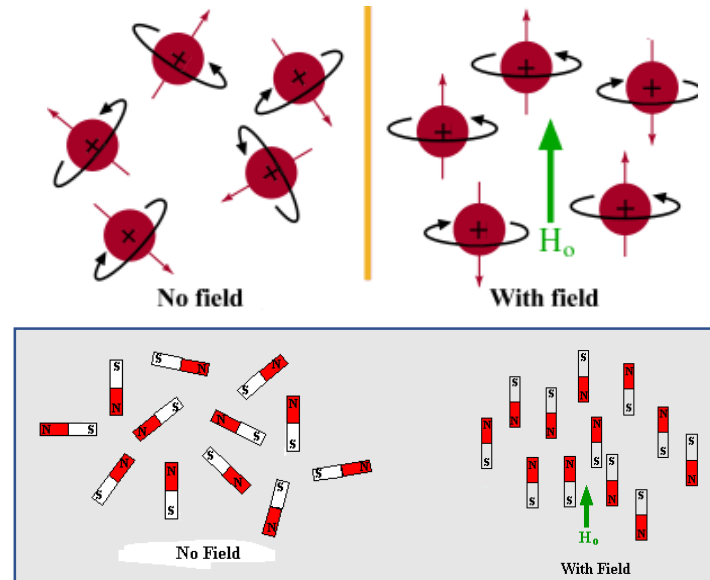

Spins align to an external magnetic field.

Principle of Nuclear Magnetic Resonance:

- 1) Align nuclear spins in a constant magnetic field.
- 2) Perturb alignment of spins using a short electro-magnetic pulse.
- 3) Measure the response over time.



# Magnetic “Resonance”

Spins can be thought of as “precessing” around the direction of the magnetic field.

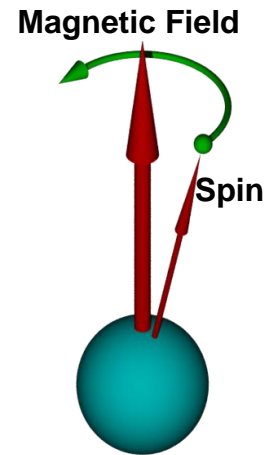
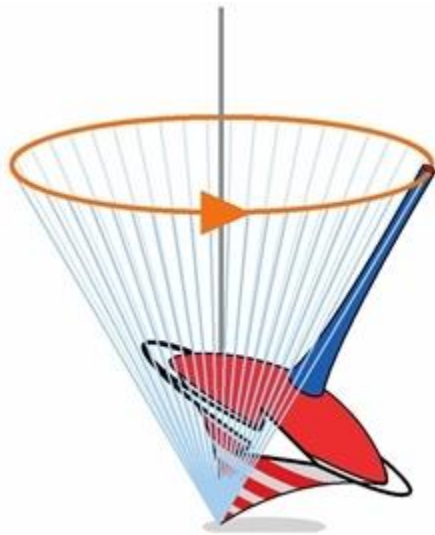

# Atomic Spin

Without a magnetic field, the two spin states (“up” and “down”) have the same energy.

In a magnetic field, these states “degenerate”: parallel spins have lower energy than anti-parallel spins.

The difference between these two states depends on magnetic field strength.

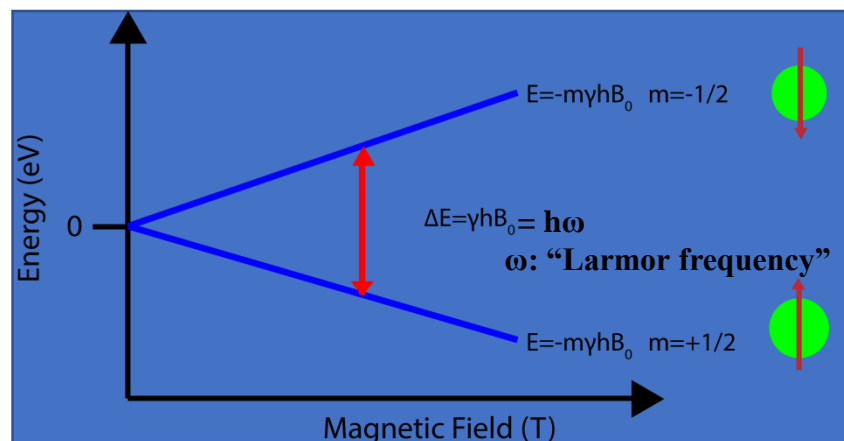





# Principle of Spin Echo Imaging

Help!

(f)MRI: Radio frequency (RF) pulses change spin precession

Static magnetic field: 3T, RF frequency: 123 MHz

UHF radio: ~300 MHz, Mobile phones: ~1GHz, Microwave: ~2 GHz

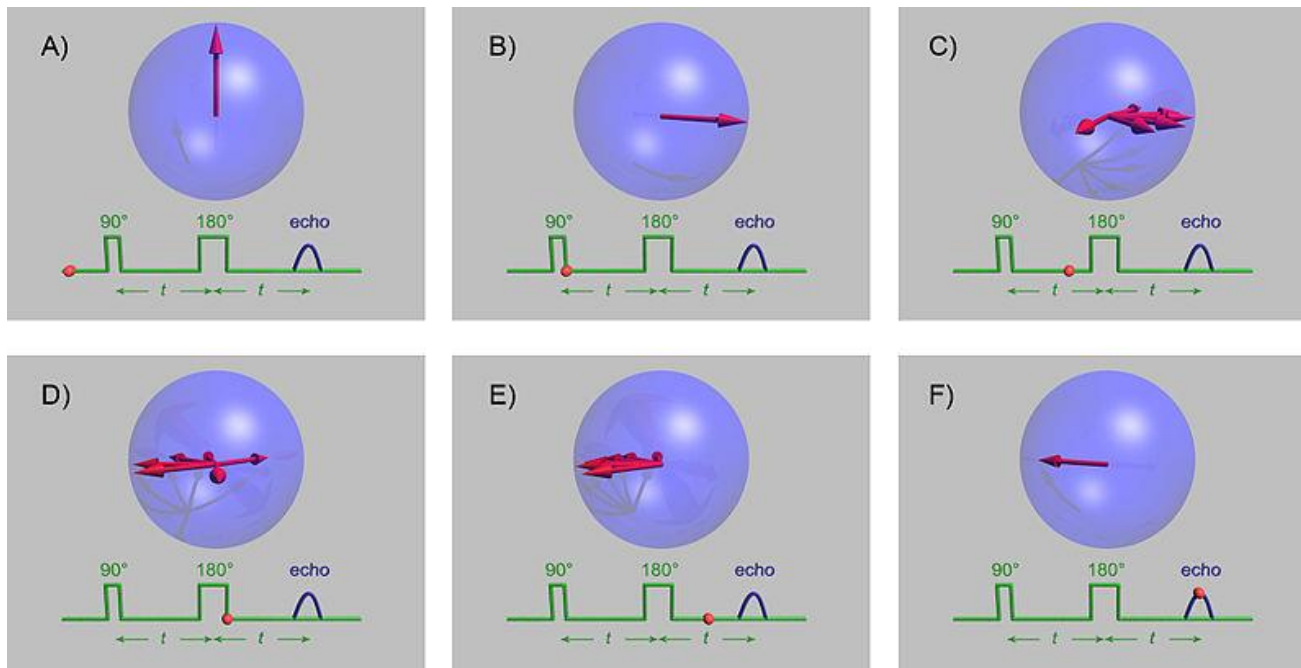

[http://en.wikipedia.org/wiki/Spin\\_echo](http://en.wikipedia.org/wiki/Spin_echo)

# Thank you!

