

# An introduction to transcranial brain stimulation (TMS and tES)

Benedikt Zoefel\*

Introduction to NeuroImaging Methods, 1st March 2017.  
MRC Cognition and Brain Sciences Unit, Cambridge, UK.

\* Thanks to Michael Ewbank

# Introduction

Common experimental approach:

Manipulate presented stimuli as independent variable, measure neural activity

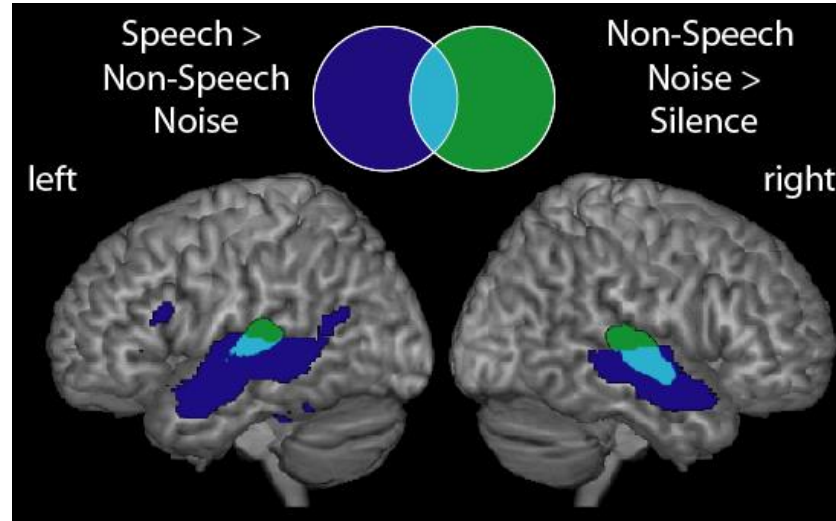

Davis and Johnsrude, 2003

Neural activity in certain brain regions is stronger for speech than for noise

However....

cannot provide evidence that neural activity is necessary or causal

**WE NEED TO MANIPULATE NEURAL ACTIVITY AS AN INDEPENDENT VARIABLE**

# Introduction: Lesion studies

*“When the electrode was applied to the speech cortex, it did not cause a man to speak.*

*It seemed at first to have no effect.*

*But if the patient tried to speak while the electrode was in place, he discovered to his astonishment (and to ours at first) that he could not find his words.”*

Penfield (1965)

However, if the lesion is permanent....

- Single or few case studies
- Might be more than a single lesion – extend beyond area under study
- The damaged region cannot be reinstated to obtain control measures
- Comparisons must be made to healthy controls
- Given brain plasticity, connections might be modified following lesions

**RECENT TECHNIQUES ENABLE SELECTIVE MANIPULATION  
OF NEURAL ACTIVITY WITHOUT SURGERY**

# Outline

- **Transcranial magnetic stimulation (TMS)**

- Principles of electromagnetic stimulation
- Physiological effects of TMS
- TMS protocols (Single pulse, rTMS, Theta burst)
- Examples of experimental work



- **Transcranial electrical stimulation (tES)**

- How does tES work?
- Physiological effects of electrical stimulation
- tES Protocols (tDCS, tACS, tRNS)
- Example of tES as a scientific and therapeutic tool
- How effective is tES?



# Part I: Transcranial Magnetic Stimulation (TMS)



# History of TMS

## Electromagnetic Induction - Faradays experiments (1831, 1839)

When an electric current is turned on or off in a (primary) coil of wire, another electric current is induced in a nearby (secondary) coil by the fluctuating magnetic field around the primary coil

The current in the TMS coil produces a magnetic field which, if changed rapidly enough, will induce an electric field sufficient to stimulate neurons.

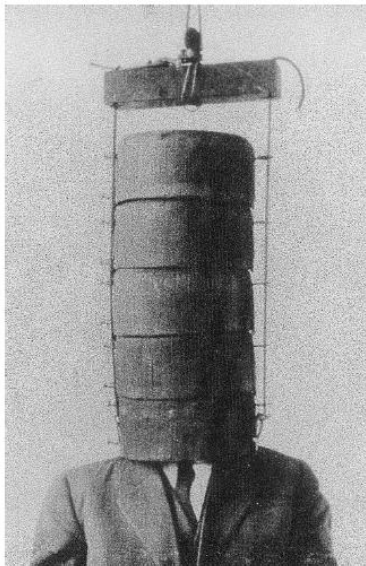
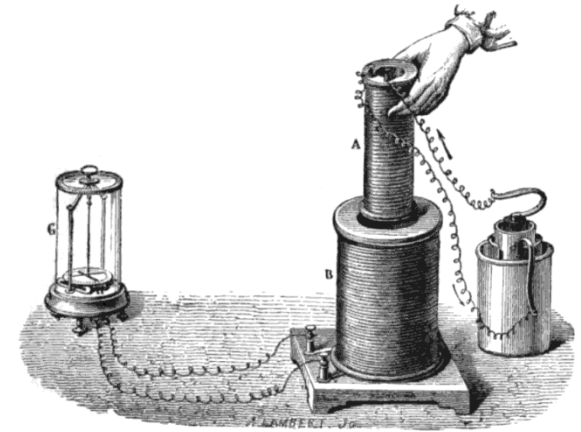

Magnusun & Stevens (1911; 1914)

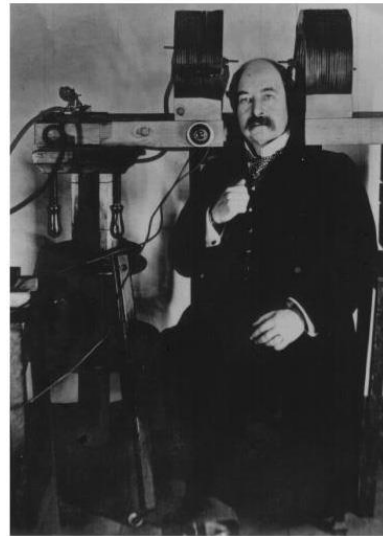

Thompson, 1910

Stimulation with magnetic fields induces phosphenes (Thompson, 1910).

# What is TMS?

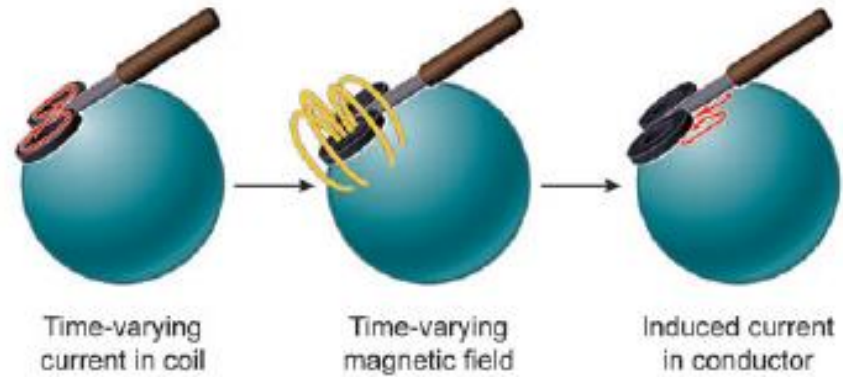
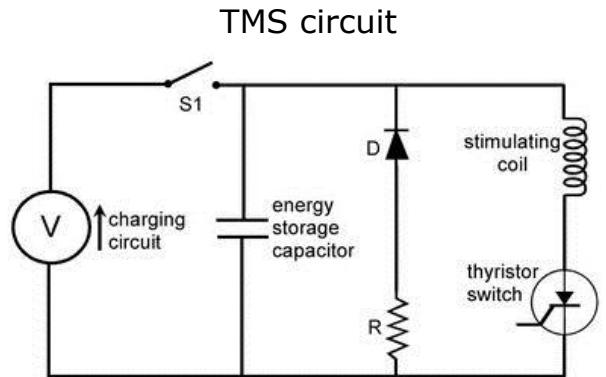

- Electric charge stored in a capacitor is discharged producing a brief, high-current pulse in a coil of wire.
- Electrical current momentarily generates a magnetic field.
- Magnetic field between 1.5T - 3T and lasts approx. 100ms
- Magnetic field penetrates scalp and skull - induces a current in the brain in a direction opposite to the original current in the coil.
- More accurately – “transcranial magnetically induced electrical stimulation”

# How does stimulation work? – Action potentials

Transmission of a signal within a neuron is carried out by the opening and closing of voltage-gated ion channels.

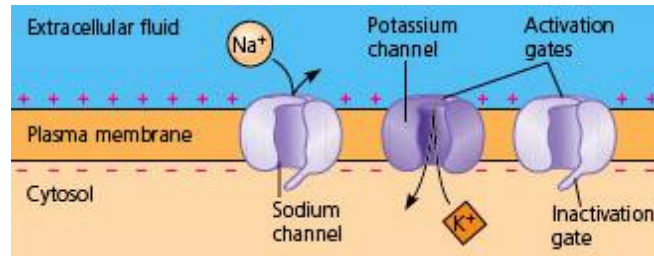

**1. Resting state** – membrane resting potential of -70 to -80mV

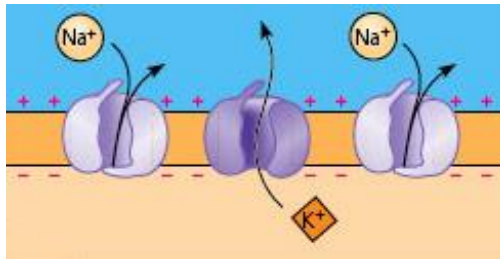

**5. Undershoot** - Potassium channels still open causing light undershoot. Sodium channels return cell to resting potential.

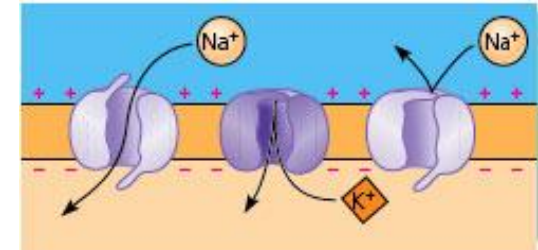

**2. Depolarization** – Stimulus opens sodium channels. Influx depolarizes membrane (Threshold between -55 and -50mV)

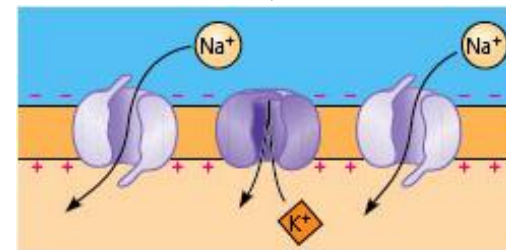

**3. Rising phase** – Opening of sodium channels makes inside of membrane positive with respect to outside (Potential shifts to +30 to +50mV).

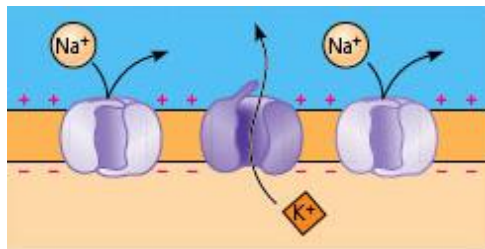

**4. Falling phase** - Sodium channels close. Potassium channels open. Potassium efflux makes inside of cell negative.



# How does TMS work?

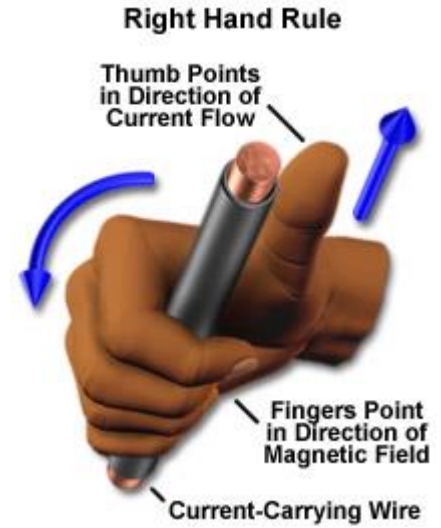
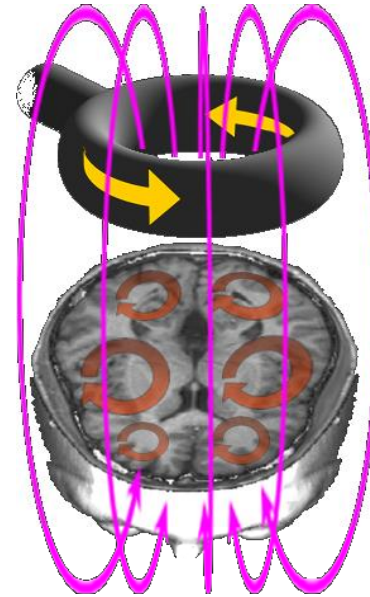
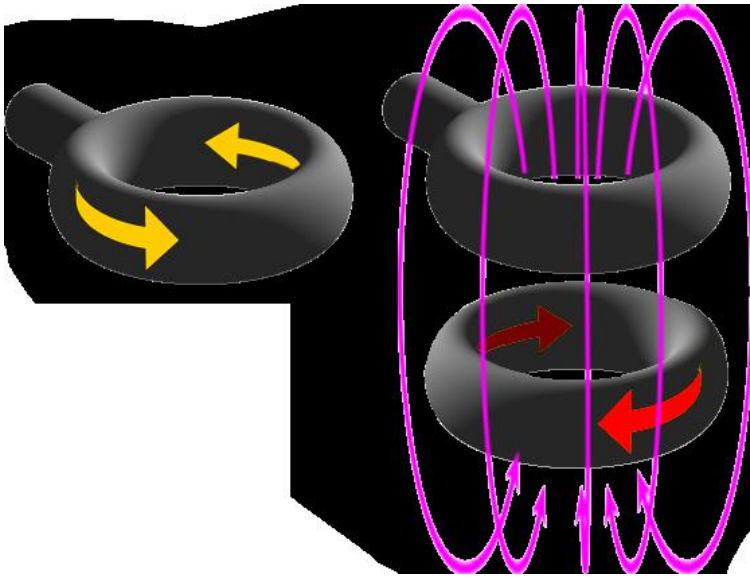

The electric field is induced perpendicularly to the magnetic field - causing ions to flow in the brain

The flow of ions alters the electric charge stored on both sides of cell membranes.

When the direction of the current is across the membrane, the induced current depolarizes cell membranes - eliciting action potentials.

Electrical field is tangential to the scalp. TMS will most likely stimulate nerve fibers that align tangential to the scalp.

Depth-focality trade off - the ability to directly stimulate deeper brain structures comes at the expense of wider electrical field spread (Deng et al., 2013).

Coils with larger half-value depth cannot be as focal as more superficial coils.

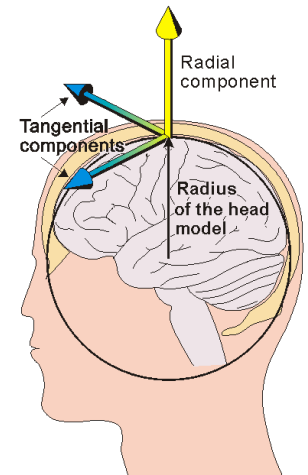

# Effects of TMS

TMS effects depend on the brain region being stimulated and protocol used.



When applied over motor cortex, electrical impulses are sent to the peripheral nerves causing muscle twitches. Muscle contraction can be measured as a 'motor evoked potential' (MEP).

# TMS protocols

## Single pulse TMS

- good temporal specificity
- can be used for mapping of motor cortical outputs or studying motor conduction time
- Single pulse effects are not thought to last long beyond the time of stimulation (Pascual-Leone et al., 2002).

## Paired pulse TMS

- Inter pulse interval 1-100 ms
- Delivered to a single target or two different brain regions using two different coils
- Can be used to study cortico-cortical interactions
- Timing can be varied to selectively stimulate inhibitory or excitatory neurons (Fitzgerald et al., 2006)
  - Interval of 3 ms - excitatory,
  - Interval of 1.5 ms - inhibitory

# TMS protocols

**Repetitive TMS (rTMS)** – rTMS generates longer-lasting changes in cortical excitability beyond the period of stimulation (hours to days but strongly dependent on protocol).

Low frequency rTMS (<1Hz) reduces excitability:

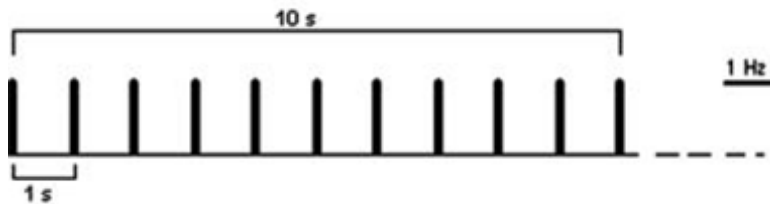

*10 s of rTMS at 1 Hz*

High frequency rTMS (>5Hz) increases excitability (Padberg et al., 2007):

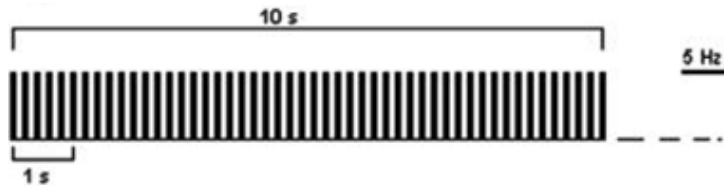

*10 s of rTMS at 5 Hz*

# TMS protocols

## Patterned rTMS

Repetitive application of short rTMS bursts interleaved by short pauses of no stimulation

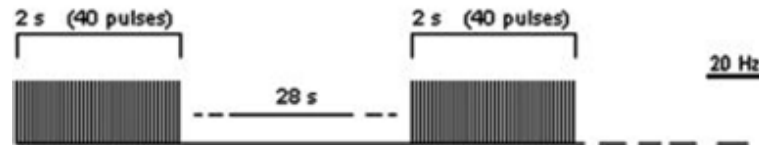

20 Hz application (trains of 2 s interleaved by a pause of 28 s)

## Theta burst stimulation (TBS) (5Hz).

Based on natural firing pattern of pyramid cells in hippocampus (Kanel & Spencer, 1961) - theta-frequency pattern of neuronal firing associated with LTP.

Continuous and intermittent patterns of delivery have opposite effects on synaptic efficiency (Huang et al., 2005):

- cTBS (over a period of 40s) leads to depression of cortical excitability (up to 60mins).
- iTBS leads to increase in cortical excitability.

# Sham stimulation

- Can be used in the same subjects
- Tilting coil 45° – maintains acoustic artefact and contact sensation – but still substantial stimulation (Lisamby et al., 2000)
- Sham coil – with acoustic artefact
- Use a control region
- Experimenter is not blinded to procedure

# Safety issues

## **Seizure induction**

Single-pulse TMS has produced seizures only in patients.

rTMS has caused seizures in patients (approx 1.4%) and neurotypical volunteers (<1%).

Only one case with TBS.

TMS produces loud click (90-130 dB) in the most sensitive frequency range (2–7 kHz). rTMS = more sustained noise. Reduced considerably with earplugs.

Local pain, headache, discomfort - More common with rTMS  
depends on location of the coil

# Examples of TMS studies



# TMS and category specificity in visual cortex

Alpha rhythm, assumed to have an inhibitory role in the brain

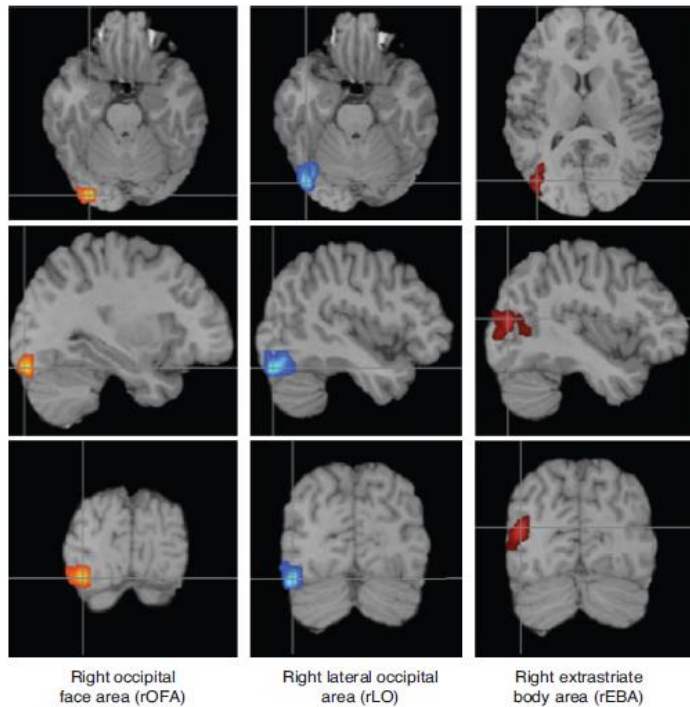

 **TMS Protocol**  
10 Hz for 500ms

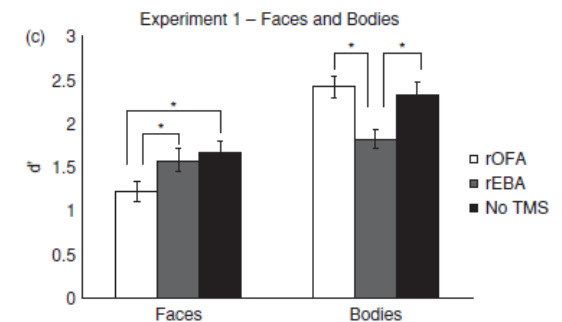
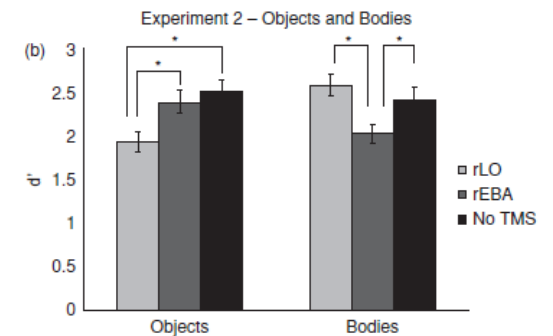
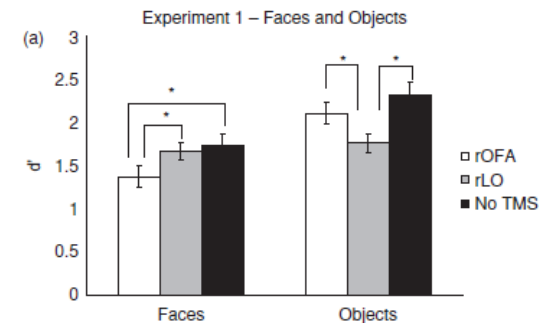

Regions of occipitotemporal cortex appear to be selective for faces, bodies and objects.

- rTMS onset concurrent with the onset of stimulus

- TMS over rOFA impaired discrimination of **faces** but not objects or bodies
- TMS over rEBA impaired discrimination of **bodies** but not faces or objects
- TMS over rLO impaired discrimination of **objects** but not faces or bodies

Pitcher et al. (2009)

# On the Role of Prestimulus Alpha Rhythms over Occipito-Parietal Areas in Visual Input Regulation: Correlation or Causation?

Vincenzo Romei,<sup>1,2,3</sup> Joachim Gross,<sup>1</sup> and Gregor Thut<sup>1</sup>

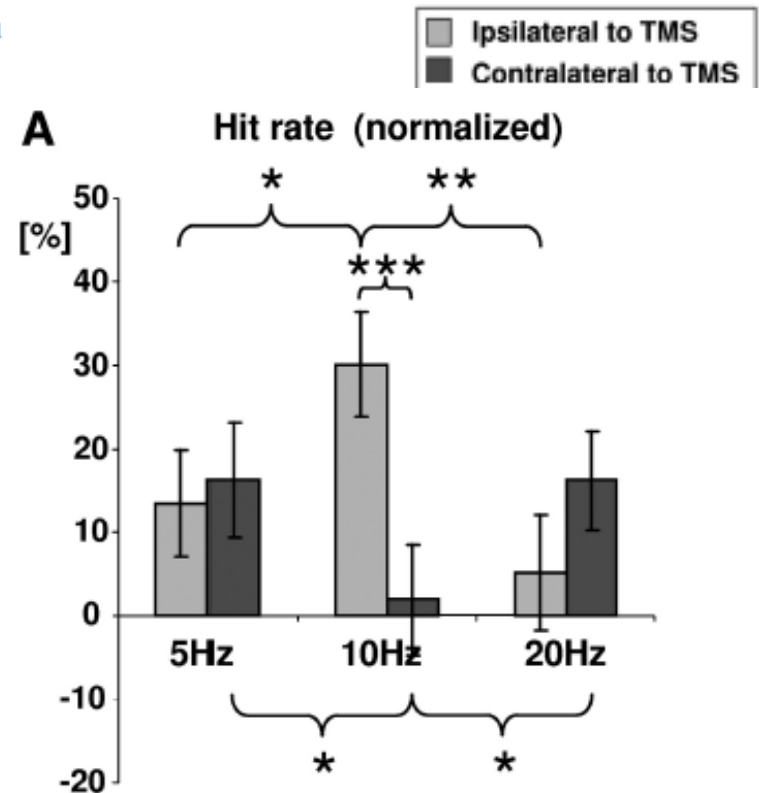
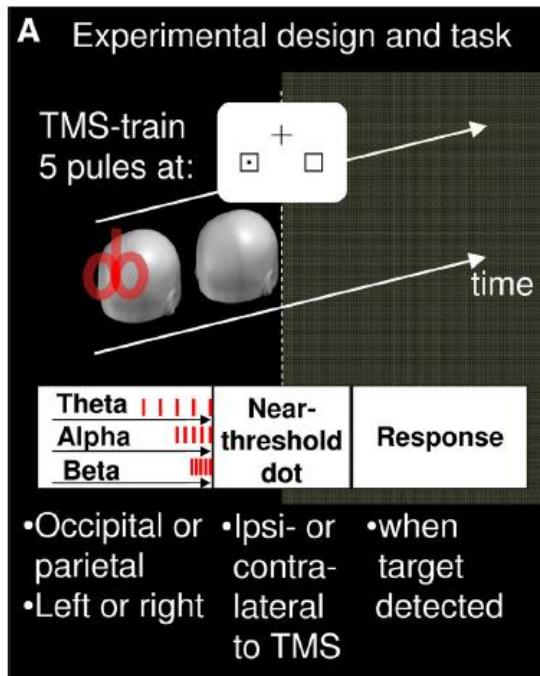

TMS affects visual detection in a frequency- and spatially specific manner

# Therapeutic use of TMS

Approved for use in treating migraine and treatment-resistant depression.

Typical use of rTMS (or theta burst) for treatment of depression – 20-40min, 5 days a week, 4-6 weeks.

Clinical benefits are marginal in the majority of reports

- Superiority of rTMS over a sham control, though the degree of clinical improvement is not large.
- Greater efficacy with longer treatment courses.
- Large variation in approaches (stimulation site, stimulus parameters etc) (Loo & Mitchell, 2005).

# TMS Summary

- **Transcranial magnetic stimulation (TMS)**
  - Works via electromagnetic induction
  - Evokes action potentials in the brain
  - rTMS can increase or decrease neuronal excitability
  - Excellent temporal resolution/ good spatial resolution
  - Safety/tolerance issues
  - Not easily controlled sham

## Part II: Transcranial electrical stimulation (tES)



### Equipment at CBU:

Two stimulators on site:

#### **neuroConn DC-STIMULATOR PLUS**

Single channel stimulator

#### **neuroConn DC- STIMULATOR MR**

MR compatible version of DC-STIMULATOR PLUS.



# History of electrical brain stimulation

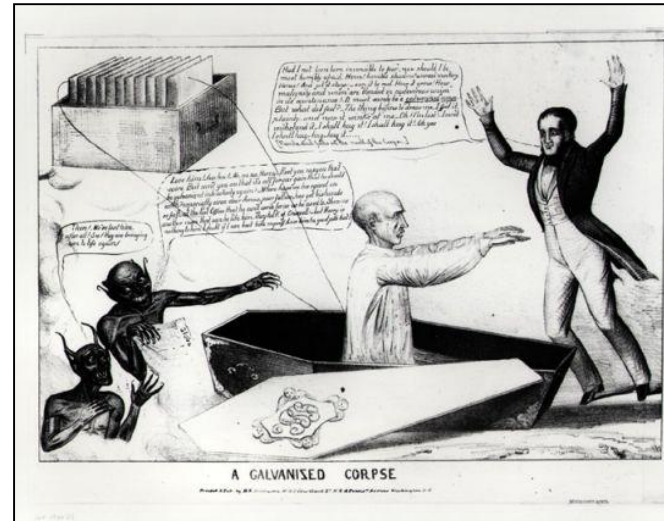
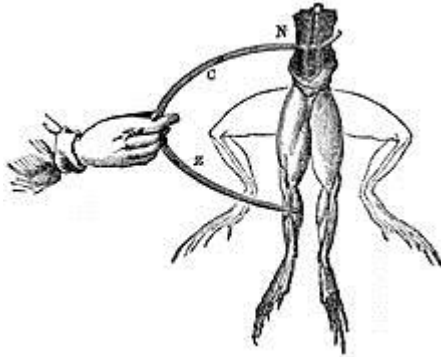

“Galvanism” - Luigi Galvani (1737-1798)



“Complete rehabilitation” of depression/psychosis following transcranial administration of electric current.

Giovanni Aldini (1804)

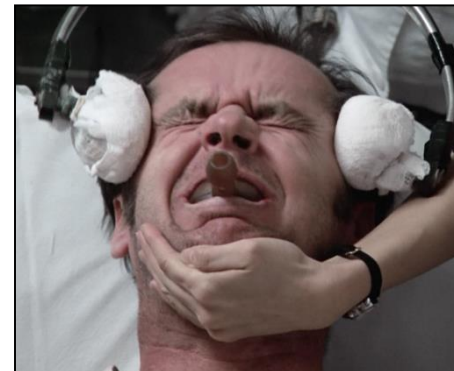

Electroconvulsive Therapy (ECT) (1938-)

10,000 x more power than tES

# Transcranial electrical stimulation 'hysteria'

**Math Skills Improved By Electric Shocks To Brain, Study Suggests**

**Science NOW** | Posted: 05/17/2013 8:38 am EDT

Like 674 people like this. Be the first of your friends.

272 32 8 57 88

GET SCIENCE NEWSLETTERS:  
Enter email

FOLLOW: Video, Cognitive Science, Math Skills, Arithmetic, Brain Science, Brain Science, Electric Currents, Electric Shock Therapy, Electroshock Therapy, Mathematics, Math Electric Shock, Emotional Intelligence, Science News

**NBC NEWS HEALTH**

TOPICS: Health care | Diet & Fitness | Alzheimer's | Body Odd | More

**SHOCKING-TREATMENTS**  
Want to be a math whiz? Try a touch of electric shock

**Want to be a math whiz? Try a touch of electric shock**

**The Body Odd,**  
Nov. 4, 2010 at 12:16 PM ET

**The Telegraph**

Home News World Sport Finance Comment Blogs Culture Travel Life Women I  
Politics Obits Education Earth Science Defence Health Scotland Royal Celebrities  
Science News Space Night Sky Roger Highfield Dinosaurs Evolution Steve Jones Sci

HOME » SCIENCE » SCIENCE NEWS

**Electric shock treatment 'improves academic performance'**

Stimulating the brain with tiny electric shocks can boost people's learning and memory ability, research has found.

"Transcranial direct current stimulation"

Pubmed results by year

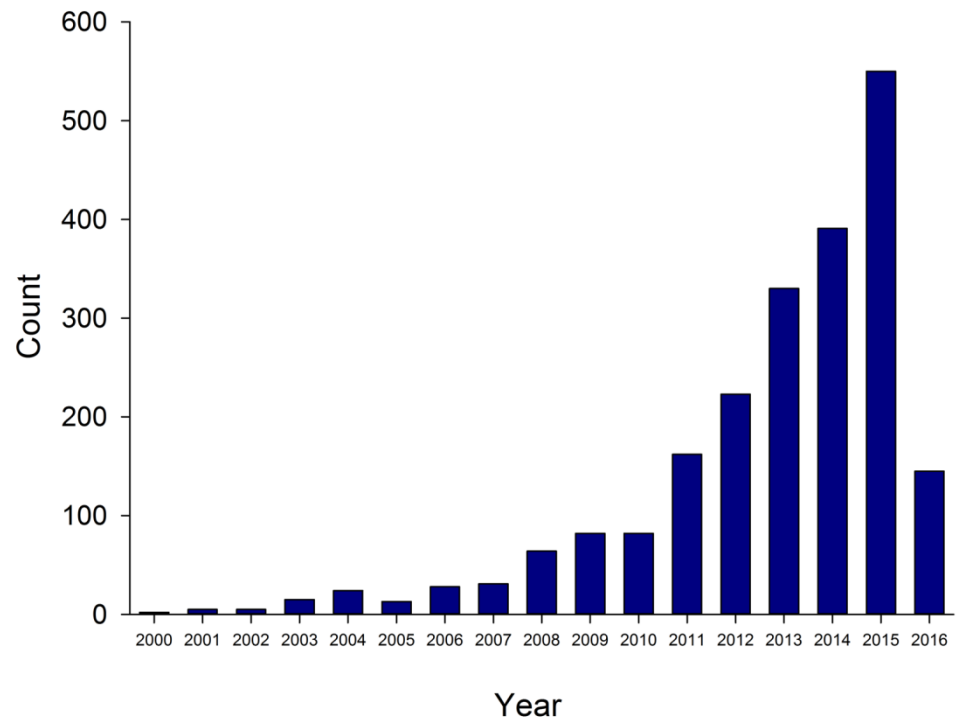

# What is tES?

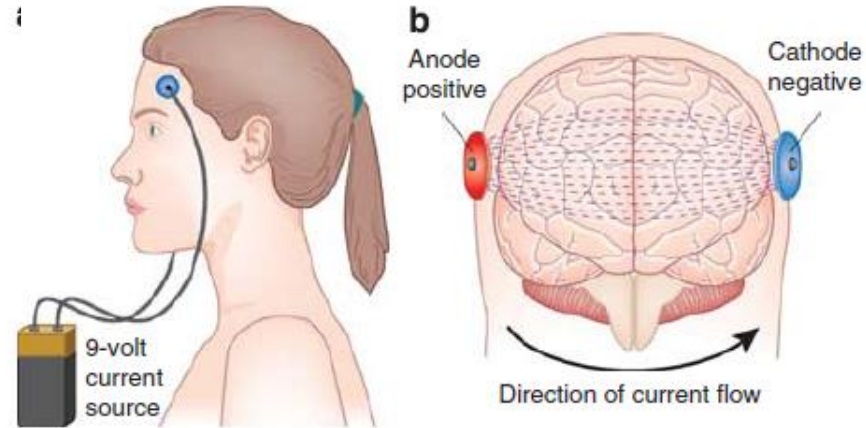
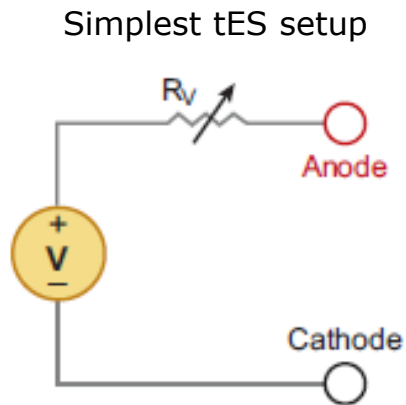

George & Aston-Jones (2010)

## **Transcranial direct current stimulation (tDCS):**

A constant direct current (DC) is applied (*i.e. a flow of electric charge that does not change direction*).

“Anodal” (“cathodal”) stimulation refers to anode (cathode) placed above or close to target of stimulation. Other electrode (often called “reference” or “return” electrode) rather arbitrarily placed above brain or body region not directly involved in task

## **Transcranial alternating current stimulation (tACS):**

Alternating current (AC) is applied (*i.e. flow of electric charge changes direction at certain frequency*).



# How does tES work? Theoretical perspective

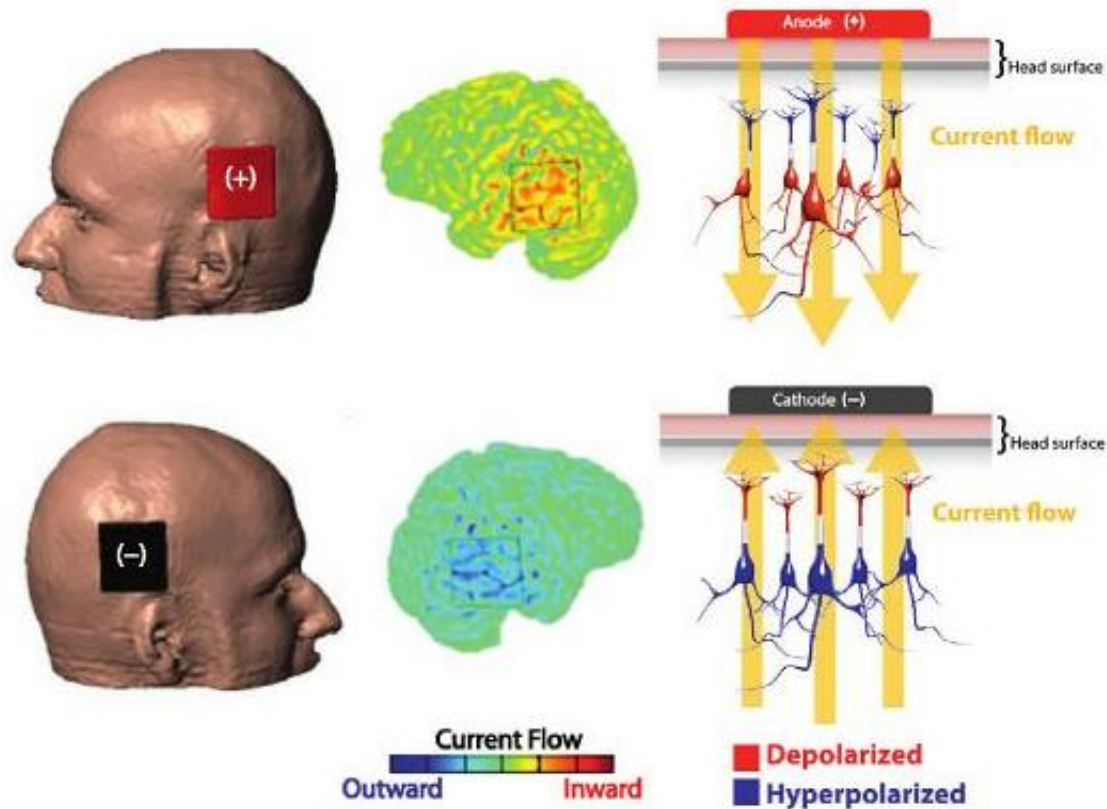

An electric current flows between two electrodes (anodal and cathodal) on the scalp.

Part of the electric current reaches the cortex (~50%).

Current flow (inward) under anodal electrode induces a *lack* of positive ions (shifts membrane potential towards depolarization). - **Increases excitability.**

Current flow (outward) under the cathodal electrode induces an *excess* of positive ions (shifts membrane potential towards hyperpolarization). - **Decreases excitability.**

# tES with TMS

tDCS induces excitability changes in motor cortex (Nitsche & Paulus, 2000)

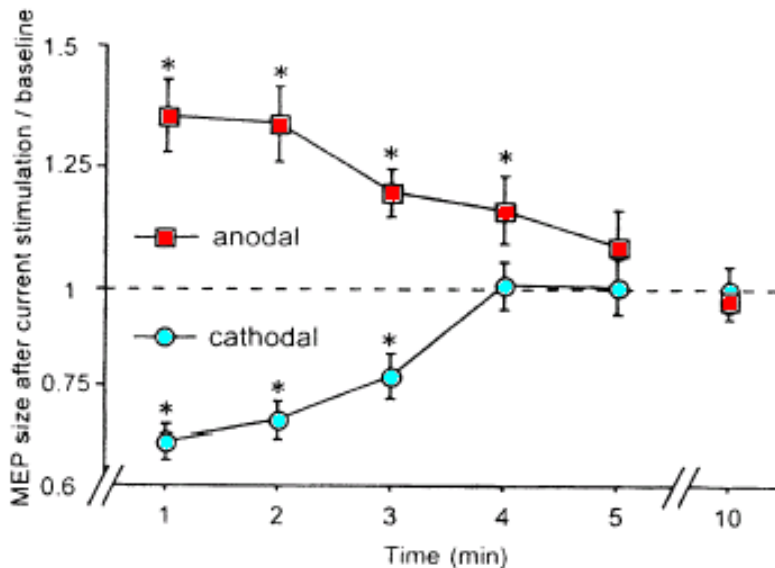
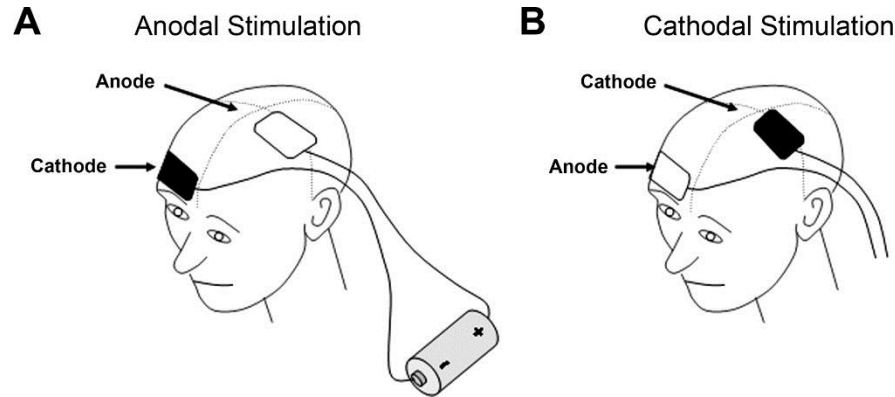

Scalp tDCS stimulation (for 5 min at 1 mA).

Nitsche & Paulus (2000)

“After-effects” last up to 90 minutes after stimulation (depending on intensity and duration of stimulation)

# How does tES work?

**tES electrical fields are far too weak to elicit action potentials:**

- 2mA = ~0.3mv (15mv rest to AP threshold) – 100x weaker than TMS

Interacts with ongoing activity (Stagg & Nitsche, 2011), i.e. with **active** regions.

- (Rate effects) - Increase in rate of action potential generation (Carandini and Ferster, 2000)
- (Timing effects) – Change in timing of action potential (Radman et al., 2007)

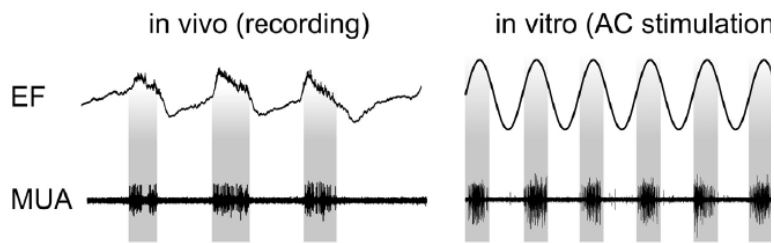

Frohlich and McCormick, 2010

Antal and Herrmann, 2016

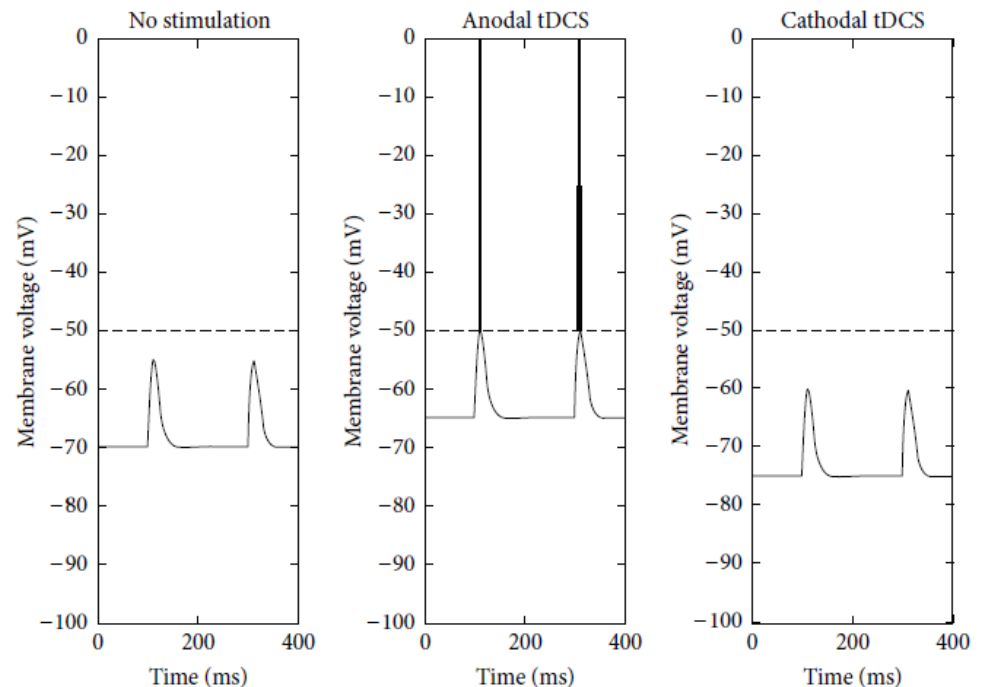

# How is tES applied?

Rubber electrodes in saline soaked sponge pads or using sticky paste, placed on the scalp.

Electrode size from  $\sim 9 - 35 \text{ cm}^2$

Stimulation sites usually based on EEG electrode placement locations

currents of 1 – 2 mA

Applied for durations of up to 20 minutes.



# tES protocols

## Direct current stimulation (tDCS)

Application of a constant current (Nitsche and Paulus, 2000)

tDCS



## Random noise stimulation (tRNS)

Several frequencies applied within a normally distributed frequency spectrum (0.1 to 100Hz low-frequency) (101 to 640Hz high-frequency) (Terney et al., 2008).

tRNS



## Alternating current stimulation (tACS)

Current is not constant but alternates between the anode and the cathode (switching polarity) with a sinusoidal waveform. Uses waveform at a specific frequency (Herrmann et al., 2013).

tACS

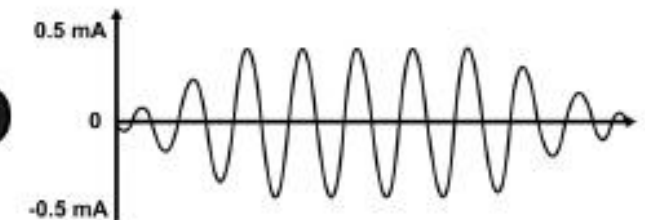

Saiote et al., (2013)

# tES protocols

## **Alternating current stimulation (tACS) –**

Alternating fields can increase or decrease power of oscillatory rhythms in the brain in a frequency-dependent manner - synchronizing or desynchronizing neuronal networks.

## **Random noise stimulation (tRNS) –**

After a depolarization, sodium channels enter an inactivated state (refractory period), but repeated stimulation may allow Na channels to be reopened in a shorter time (Schoen and Fromherz, 2008).

A DC stimulus can open Na channels just once, whereas repeated pulses (tRNS) can induce multiple ionic influxes (Terney et al., 2008).

## **Stochastic resonance –**

A signal that is too weak to be detected can be boosted by adding white noise to the signal – Amplification of subthreshold oscillatory activity - might increase neural firing synchronization within stimulated regions.

# tES – state, duration and amplitude dependent effects

## **State dependent effects of tDCS**

- Anodal stimulation increases excitability of motor cortex during passive condition.
- When performing a motor exercise, excitability was lower after both anodal and cathodal stimulation (Antal et al., 2007).

## **Non-linear stimulation intensity-dependent effects**

- 1 mA cathodal tDCS decreases motor cortex excitability.
- At 2 mA, both anodal and cathodal tDCS resulted in an increase of excitability (Batsikadze et al., 2013).

## **Duration of stimulation**

- 13 min anodal tDCS enhances excitability for up to 60 min.
- Prolonging stimulation duration for 26 min converts the after-effects into inhibition (Monte-Silva et al., 2013).

# tES – current challenges

1. Effects are state-, amplitude- and duration-dependent
  - “Anodal stimulation = excitatory” and “cathodal stimulation = inhibitory” too simplistic
  - Only motor system well investigated
2. Current flow is more complicated than often assumed
  - Effects of stimulation protocol, electrode position, electrode size, experimental task
  - Position of “reference” electrode is critical
  - Optimal stimulation parameters often unknown
3. Studies often not comparable
  - Use of different stimulation protocols and/or tasks
4. Current flow relatively unspecific, stimulation of regions other than target cannot be excluded
5. Effects are often small

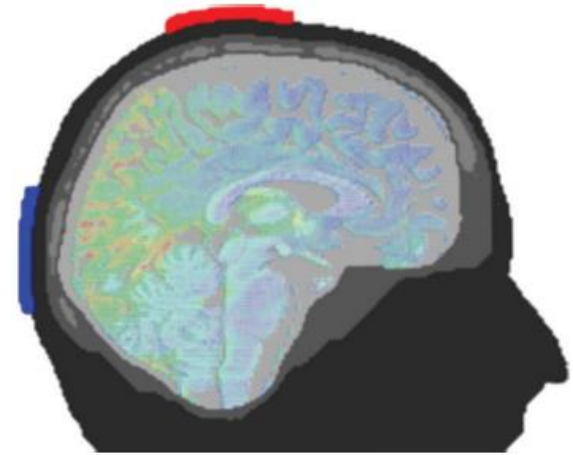

Antal and Herrmann, 2016

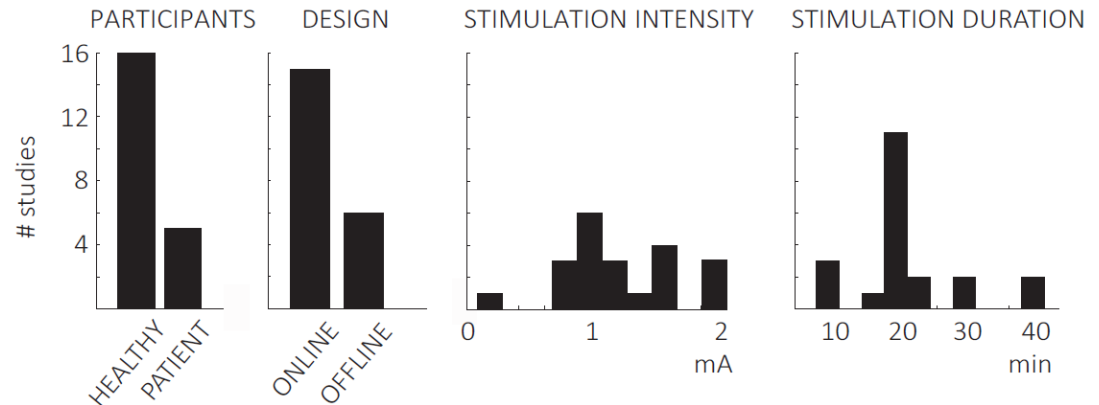

Zoefel and Davis, 2016



# tES – Safety issues

tES does not cause epileptic seizures or reduce seizure threshold in animals (Liebetanz et al., 2006). No reports of seizures using tES in humans.

Slight itching or heating under the electrode - (tRNS and tACS are less easily detectable).

## **Sham stimulation**

Current flow is ramped up and down (e.g., for 15 seconds).

Not easily detectable

**Safety:** Cathodal can be placed on an extracephalic location (e.g. shoulder). Never place both electrodes on any other part of the body apart from the head - **currents passing across the heart can be dangerous!**



# tES vs. TMS

**Pros –** tES easily tolerated, silent, sham hard to distinguish, low cost, portable

**Cons –** Lower spatial resolution; underlying mechanisms less understood

## Examples of tES studies

# Causal Evidence for a Mechanism of Semantic Integration in the Angular Gyrus as Revealed by High-Definition Transcranial Direct Current Stimulation

 Amy Rose Price,<sup>1,2</sup>  Jonathan E. Peelle,<sup>3</sup>  Michael F. Bonner,<sup>1</sup> Murray Grossman,<sup>1,2</sup> and Roy H. Hamilton<sup>1,2</sup>

Electrode placement



Left angular gyrus electrode montage

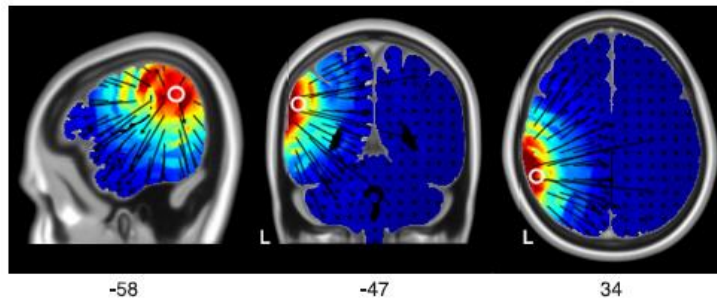

**A** Word-pair task

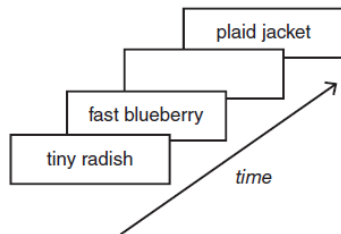

**B** Letter-string task

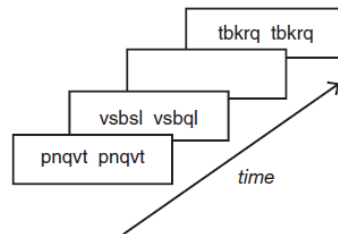

**A** Word-pair results

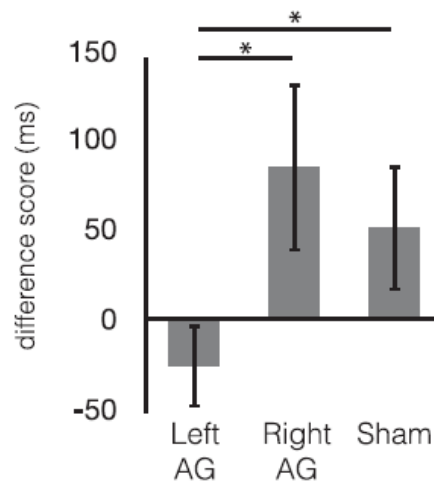

**B** Letter-string results

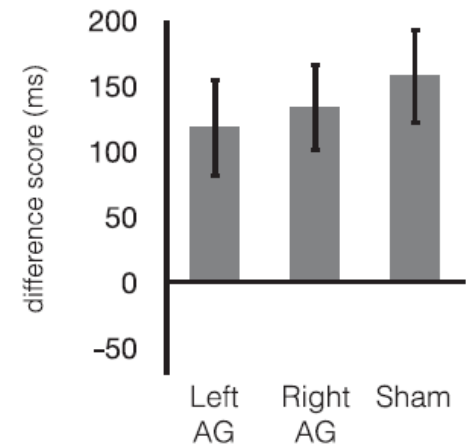

# tACS – Effects of phase coupling on cognitive performance

Cortical circuits for central executive functions have been shown to emerge by theta (~6 Hz) phase coupling of cortical areas.

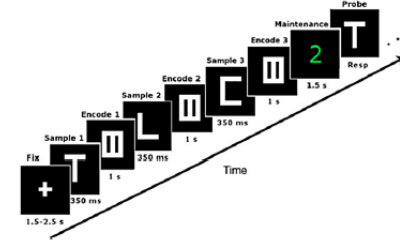
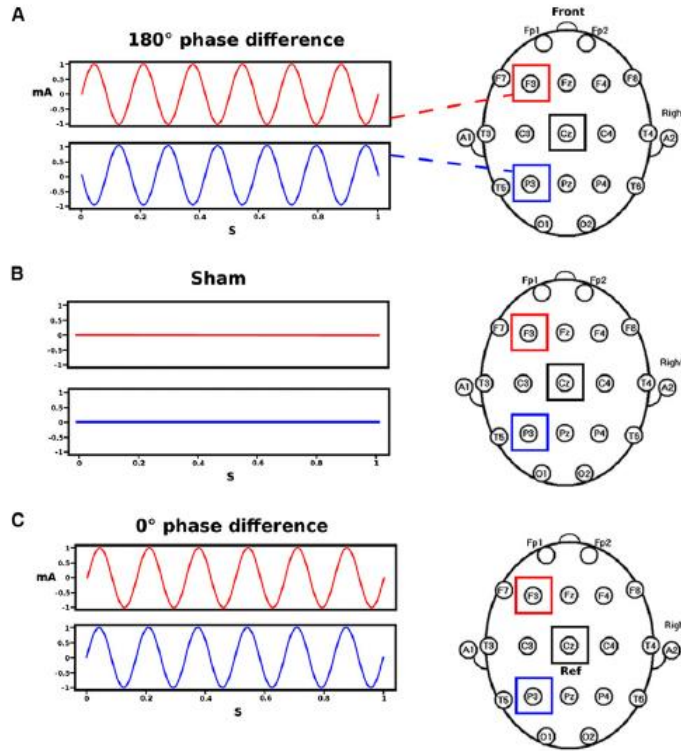

Subjects performed a delayed letter discrimination task.

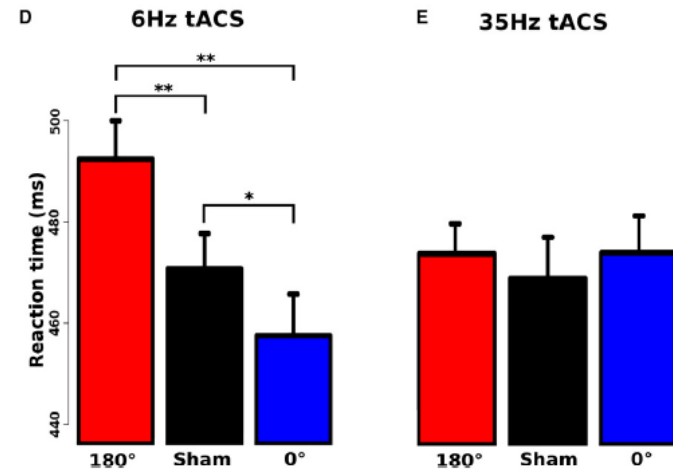

tACS simultaneously applied at 6 Hz over left prefrontal and parietal cortex with

- Relative 0° (“synchronized” condition) phase
- 180° (“desynchronized” condition) phase
- Sham condition.

Frontoparietal theta synchronization improves visual memory-matching. Desynchronization deteriorates performance.

Evidence of causality of theta phase-coupling of distant cortical areas for cognitive performance.

# Therapeutic use of tES

## Treatment of depression

40 patients with moderate to severe major depression

- Left DLPFC (21 patients),
  - occipital (9 patients)
  - sham stimulation (10 patients).
- 10 sessions tDCS - 2mA

Only prefrontal tDCS reduced depressive ratings

- effects were stable 30 days later (Boggio et al., 2008).

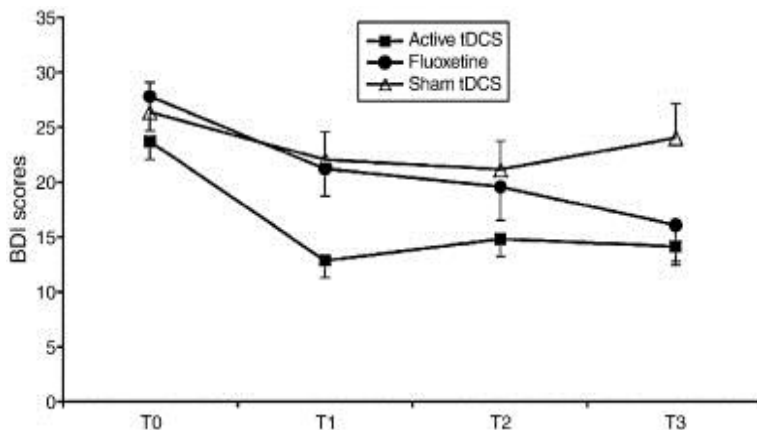
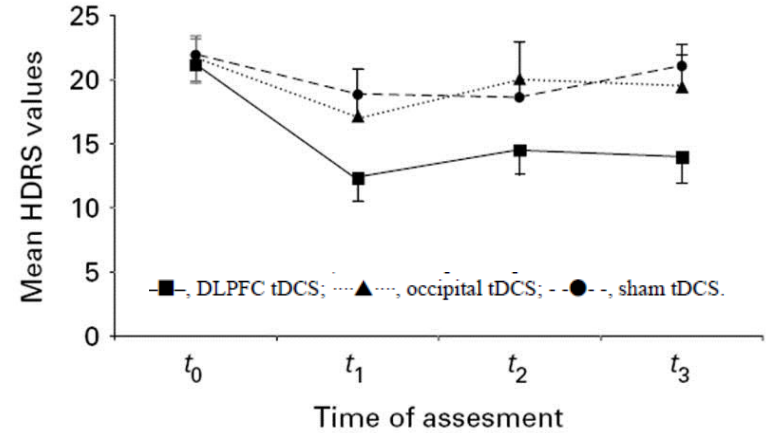

- (i) Size of clinical improvement delivered by tDCS to DLPFC similar to effects of antidepressant medication
- (ii) Effects of tDCS faster than those of pharmacological treatment

(Rigonatti et al., 2008).

# How effective is tES? On the one hand...



Reviews and perspectives

Evidence that transcranial direct current stimulation (tDCS) generates little-to-no reliable neurophysiologic effect beyond MEP amplitude modulation in healthy human subjects: A systematic review

Jared Cooney Horvath\*, Jason D. Forte, Olivia Carter

University of Melbourne, School of Psychological Sciences, Melbourne, VIC, Australia

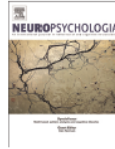

NEUROSCIENCE

## *Cadaver study challenges brain stimulation methods*

Unusual test of transcranial stimulation shows that little electrical current penetrates the skull

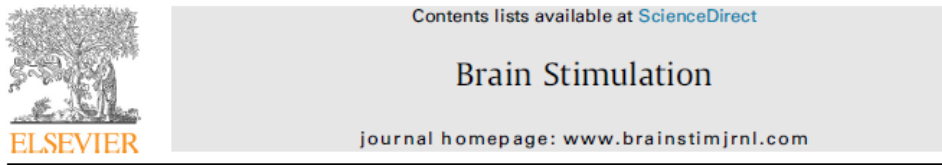

Quantitative Review Finds No Evidence of Cognitive Effects in Healthy Populations From Single-session Transcranial Direct Current Stimulation (tDCS)

Jared Cooney Horvath\*, Jason D. Forte, Olivia Carter

University of Melbourne, Melbourne School of Psychological Sciences, Redmond Barry Building, Melbourne, VIC 3010, Australia



New interventions that promise cognitive enhancement (such as brain stimulation) are typically marked by high levels of early positive results that are typically not sustained over longer periods - probably due to publication bias (Dwan, Gamble, Williamson & Kirkham, 2013; Scherer & Langenberg, 2007).

# How effective is tES? On the other hand...

Conceptual and  
Procedural Shortcomings  
of the Systematic Review  
“Evidence That  
Transcranial Direct  
Current Stimulation  
(tDCS) Generates Little-  
to-no Reliable  
Neurophysiologic Effect  
Beyond MEP Amplitude  
Modulation in Healthy  
Human Subjects: A  
Systematic Review” by  
Horvath and Co-workers

A. Antal  
*Department of Clinical Neurophysiology  
University Medical Center, Georg-August University  
Göttingen, Germany*

D. Keiser  
*Department of Psychiatry, Psychotherapy and Psychosomatics  
Ludwig-Maximilian University Munich  
Munich, Germany*

A. Priori  
*Fondazione IRCCS Ca' Granda Ospedale Maggiore Policlinico  
Milan, Italy  
Università degli Studi di Milano  
Milan, Italy*

F. Padberg  
*Department of Psychiatry, Psychotherapy and Psychosomatics  
Ludwig-Maximilian University Munich  
Munich, Germany*

M.A. Nitsche  
*Department of Clinical Neurophysiology  
University Medical Center, Georg-August University  
Göttingen, Germany*

Combining studies with a large variability in experimental factors to a meta-analysis might not be useful

Animal studies have demonstrated consequences of tES in electrophysiological recordings

“Blind fishing” for tES effects might not be the right approach – systematic tests based on clear hypotheses are needed



# Summary

- **Transcranial electrical stimulation (tES)**
  - Electric current flows into brain
  - tDCS shifts neuronal membranes towards (or away from) depolarization
  - Direct or alternating current or more “complicated” protocols
  - Interacts with task – “neuromodulation”
  - Easily tolerated
  - Well controlled sham
  - Relatively poor spatial resolution
  - Efficacy still unclear and several challenges to overcome

TMS and tES are promising tools to investigate the causal role of neural activity for stimulus processing. Standardized protocols have yet to be found for tES.

# Reading

## Useful papers

Walsh V, Cowey A. (2000) *Transcranial magnetic stimulation and cognitive neuroscience*. Nature Reviews Neuroscience 1 (1): 73-80.

Wagner T, Valero-Cabre A, Pascual-Leone A. (2007) *Noninvasive human brain stimulation*. Annu Rev Biomed Eng 9:527–565.

Bolignini N, Ro, T. (2011) *Transcranial magnetic stimulation: disrupting neural activity to alter and assess brain function*. J Neuroscience, 30(29): 9647-50

Nitsche MA, Cohen LG, Wassermann EM, Priori A, Lang N et al. (2008) *Transcranial direct current stimulation: State of the art 2008*. Brain Stimul 1: 206-223

Stagg CJ, Nitsche MA. (2011) *Physiological basis of transcranial direct current stimulation*. Neuroscientist 17, (1): 37–53.

Herrmann CS, Rach S, Neuling T, Struber D (2013) *Transcranial alternating current stimulation: a review of the underlying mechanisms and modulation of cognitive processes*. Front Hum Neurosci 7: 279.

## Books

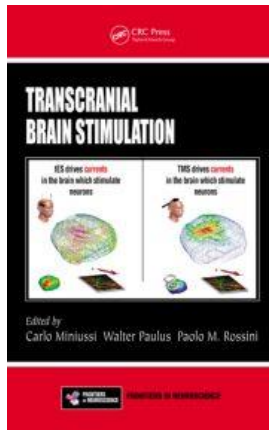

Transcranial Brain Stimulation  
(Edited by Miniussi, Paulus, Rossini).

Oxford Handbook of Transcranial Stimulation  
(Edited by Wassermann, Epstein, Ziemann, Walsh & Lisanby).

